



**6th INTERNATIONAL DOCTORAL CONSORTIUM ON
INFORMATICS ENGINEERING EDUCATION
RESEARCH
IEER**

**International annual event, organized since 2010 by the Vilnius
University Institute of Mathematics and Informatics**

Organisers:
Prof. dr. Valentina Dagiene, chair
Dr. Anita Juškevičienė
Lina Vinikienė

December 8–12, 2015
Druskininkai, Lithuania

The Sixth International Doctoral Consortium is organized by Vilnius University Institute of Mathematics and Informatics on December 8–12, 2015 in Druskininkai, Lithuania.

The aims of the Doctoral Consortium are:

- To offer a friendly forum for doctoral students to discuss their research topics, research questions and design in the field of computing education / educational technology – informatics engineering and education.
- To receive constructive feedback from their peers and senior researchers, to help with choosing suitable methodology and strategies for research.
- To support networking with other researchers in the informatics engineering education research field.
- To discuss any relevant questions related to research and academic life.

Participants

The doctoral consortium is designed primarily for students who are currently enrolled in any stage of doctoral studies with a focus on informatics / informatics engineering / computing education research. Students, who are considering doctoral studies but not have yet a formal doctoral student researcher status, may participate as well.

Senior researchers in the field will provide feedback and suggestions for improvement of the research proposals.

Requirements

Each participant should submit a document, which includes the following information:

- a brief background of the applicant including information about prior studies, research topic, publications if any, and possible teaching experience;
- a summary of his/her research, including motivation, any relevant background, and main literature to contextualize the research, research questions, methodologies used or planned, and possible results obtained;
- questions related to the research that the applicant would like to discuss and get feedback on in the doctoral school.

The summary will be made available for other participants of the doctoral school to allow providing feedback and preparing questions on the research.

AGENDA

Tuesday, December 8

- 16:45 *Bus from Vilnius airport*
19.00 *Dinner*
20:30 *Welcome and discussion in sauna (please bring your bath suits)*

Wednesday, December 9

Chair: Valentina Dagienė

(8.30 – Doctoral students should bring their posters at hall to be exposed)

- 07.30 – 09.00 *Breakfast*
9.00 – 09.30 Introduction (Valentina Dagienė)
09.30 – 10.30 Päivi Kinnunen (Aalto university, Finland) What students expect to study in CS degree?
10.30 – 11.00 *Coffee break*
11.00 – 12.00 Arnold Pears (Uppsala university, Sweden) What characterises engineering education?
12.00 – 13.00 *Lunch*
13.00 – 14.00 Don Passey (Lancaster University, United Kingdom) New computer science and computing curricula in schools – what perspectives should we research and how?
14.00 – 15.00 Erik Barendsen (Radboud University & Open University of the Netherlands) Investigating teacher knowledge and student learning
15.00 – 15.30 *Coffee break*
15.30 – 17.30 Student's poster presentation: your BIG research idea (for each: 5 min. presentation + 5 min. questions).
17.30 – 18.30 *Dinner*
18.30 – 20.00 Continuation of the student's poster presentation. Reflection and discussions

Thursday, December 10

Chair: Anita Juškevičienė

07.30 – 09.00 *Breakfast*

Work in TWO streams:

(I) First year doctoral students, (II) Advanced doctoral students

| I STREAM | II STREAM |
|---|---|
| 09.00 – 12.00 Lectures 09.00 – 10.30 Päivi Kinnunen (Aalto University, Finland). Research methods and designs in computing education research. 10.30 – 11.00 <i>Coffee break</i> 11.00 – 12.00 Andrej Brodnik (University of Ljubljana, Slovenia). Suggestions and criteria for writing informatics education doctoral thesis. | 09.00 – 12.00 Work in small groups (2-3 students with a senior researcher). Coordinators: Erik Barendsen, Ján Gunčaga, Mattia Monga, Don Passey, Sergej Pozdniakov 10.30 – 11.00 <i>Coffee break</i> |

12.00 – 13.00 *Lunch*

13.00 – 14.00 Gerald Futschek (Vienna University of Technology, Austria). Criteria for writing informatics education doctoral thesis from a reader's viewpoint.

14.00 – 15.30 Individual work. Improve (re-write) your poster which summarizes your research: BIG research question, goal, subtasks, data collection and analysis methods, theoretical framework, scope, and use of results

15.30 – 16.00 *Coffee break*

16.00 – 17.30 Reflection on students' posters: all participants will read posters and write down their questions and comments.

17.30 – 18.30 *Dinner*

18.30 – 20.00 Continuation of the work in small groups.

Friday, December 11

Chair: Anita Juškevičienė

07.30 – 09.00 *Breakfast*

09.00 – 10.30 Work in small groups (2-3 students with a senior researcher). Coordinators: Erik Barendsen, Andrej Brodnik, Gerald Futschek, Ján Gunčaga, Mattia Monga, Don Passey, Sergej Pozdniakov

10.30 – 11.00 *Coffee break*

11.00 – 12.00 Individual work. Improve your posters again

12.00 – 13.00 *Lunch*

13.00 – 14.00 Continuation of the individual work

14.00 – 15.30 Final presentation of your research work and discussion (5 min. for each student)

15.30 – 16.00 *Coffee break*

16.00 – 17.30 Final discussion and overview (all supervisors)

18.30 – 20.00 Farewell together: doctoral students, supervisors, NordNICE partners, and teachers

Saturday, December 12

07.30 – 09.00 *Breakfast*

09.30 *Departure to Vilnius airport*

SENIOR RESEARCHERS

| | |
|--|----|
| Investigating teacher knowledge and student learning | |
| Barendsen Erik..... | 8 |
| Suggestions and criteria for writing informatics education doctoral thesis | |
| Brodnik Andrej..... | 8 |
| Criteria for writing informatics education doctoral thesis from a reader's viewpoint | |
| Gerald Futschek..... | 9 |
| What students expect to study in CS degree? | |
| Kinnunen Päivi..... | 9 |
| New computer science and computing curricula in schools – what perspectives should we research and how? | |
| Passey Don..... | 10 |
| What characterises engineering education? | |
| Pears Arnold..... | 10 |
| Dagienė Valentina..... | 12 |
| Gunčaga Ján..... | 12 |
| Juškevičienė Anita..... | 12 |
| Kurilovas Eugenijus..... | 12 |
| Monga Mattia..... | 13 |
| Pozdniakov Sergej..... | 13 |

SUMMARIES OF STUDENTS

| | |
|---|----|
| Gamification methods to teach informatics engineering | |
| Beresnevičius Gytautas..... | 14 |
| Design and development of constructivists learning objects for theoretical computer science and scientific computing education | |
| Dolgopolovas Vladimiras..... | 17 |
| Visual learning objects modification research to personalized learning | |
| Dvareckienė Viktorija..... | 22 |
| Elaboration of preparation system for IT talents | |
| Erdősné Németh Ágnes..... | 25 |
| Sustaining Computer Science Competences in Italian Secondary Schools | |
| Giaffredo Silvio..... | 28 |
| Computational Thinking in Dutch Secondary Education | |
| Grgurina Nataša..... | 32 |
| Data Management in Secondary Computing Education | |
| Grillenberger Andreas..... | 36 |
| E-learning objects design model based on semantic web technologies | |
| Gudoniene Daina..... | 41 |
| Virtual laboratories in computer science education | |
| Janiga Rober, Gunčaga Ján..... | 44 |

| | |
|---|----|
| Free software strategies of managing information and communication technology infrastructure in Estonia | |
| Laugasson Edmund | 50 |
| Project metrics and tools in agile software projects | |
| Mäkiahho Pekka..... | 54 |
| Collaborative learning using ict Creation, implementation and evaluation of pedagogical scenarios in secondary schools | |
| Naujokaitiene Justina | 57 |
| Model of Developing CT in Comprehensive School Lessons | |
| Palts Tauno..... | 61 |
| Physical Computing in Computer Science Education | |
| Przybylla Mareen | 64 |
| Computational thinking: a new didactical approach for teaching introductory programming within the humanities | |
| Spangsberg Thomas | 71 |
| Modelling of informatics concepts through interactive tasks | |
| Stupurienė Gabrielė | 74 |
| Modelling of management decisions' processes in specialists' training system itle | |
| Tkachenko Kostiantyn | 78 |
| Assessment in computer science education under pressure | |
| Vegt Willem van der | 81 |
| Research of tests generation and validation for informatics education | |
| Vinikienė Lina..... | 85 |

SENIOR RESEARCHERS

INVESTIGATING TEACHER KNOWLEDGE AND STUDENT LEARNING

Barendsen Erik



Prof. dr. Erik Barendsen (1966) received a PhD in mathematics and informatics from Radboud University Nijmegen in 1995. He is currently professor of computing education at Open Universiteit, where he holds the first and only chair on this subject in The Netherlands. He is associate professor at the Institute for Computing and Information Sciences of Radboud University Nijmegen.

His research interests include informatics education, digital literacy, computational thinking, science education, teachers' PCK, and context-based education. Erik Barendsen chairs a Dutch working group on academic curriculum development and informatics education research. He supervises a group of doctoral students and other researchers. Furthermore, he is chairman of the national committee redesigning the informatics curriculum in Dutch secondary education.

SUGGESTIONS AND CRITERIA FOR WRITING INFORMATICS EDUCATION DOCTORAL THESIS

Brodnik Andrej



Andrej Brodnik received his PhD in Computer Science from the University of Waterloo, Ontario, Canada. His main research interests include succinct data structures, ubiquitous systems, and Computer Science education.

Dr. Brodnik holds a position of Professor at the University of Primorska, Slovenia, and with a University of Ljubljana, Slovenia. He held also a position of Adjoint Professor with the University of Technology, Luleå, Sweden. At the University of Primorska he also served as a vice-rector and as a director of Primorska Institute of Natural Sciences and Technology.

Before joining University of Primorska he was a CTO at ActiveTools, Slovenia. Among other projects he was also a chief architect of a product "*ClusterServer*" of TurboLinux that received a number of prestigious awards including "*Best Web Solution*" at Comdex '99, Las Vegas, "*Best Product Award for Enterprise-class customer*" at IT 2000 Sydney, Australia, and "*Best on INFOS*" at INFOS 2000 Ljubljana, Slovenia. He was also a senior developer at Effnet AB and one of the authors of the Luleå forwarding algorithm. Currently he is heading among others two project in the area of e-health and a project in reverse logistic.

Dr. Brodnik is winner of, among others, *Boris Kidrič Foundation Award* (Slovenian national scientific award), *Fullbright Scholarship*, *ITRC/ICR Fellowship*, *Innovation Cup* and *IBM Faculty Award*, *University of Primorska Golden plaque*, and *National award for exceptional achievements in higher education*. He is author of over 100 scientific papers and conference contributions and of 6 international patents. Services SCOPUS and WoS list over 300 citations of his work.

CRITERIA FOR WRITING INFORMATICS EDUCATION DOCTORAL THESIS FROM A READER'S VIEWPOINT

Gerald Futschek



Gerald Futschek is Associate Professor at the Department of Software Technology and Interactive Systems at Vienna University of Technology, Past President of the Austrian Computer Society OCG. He studied Mathematics and Informatics and received his PhD in 1984. He works on several initiatives to increase the digital fluency of all people and to prevent the digital divide: European Computer Driving Licence (ECDL), International Bebras Contest on Informatics and Computational Thinking, e-Learning for prisoners, etc. He is scientific leader of the Austrian Informatics Olympiad (IOI). His research interests are Software

Verification and Informatics Didactics. He has a lot of experience in teaching academic courses on Informatics Didactics, Software Engineering, Software Verification and Validation, Proofing of Software Correctness, Algorithms and Data Structures, Introduction to Programming mainly at Vienna University of Technology, some of them also at University of Zurich and at Pristina University of Business and Technology. He is also highly involved in organizing the masters program of informatics teacher education.

WHAT STUDENTS EXPECT TO STUDY IN CS DEGREE?

Kinnunen Päivi



Dr. Päivi Kinnunen has a PhD in computing education and Licentiate degree in the Art of Education. She has a title of Docent at Helsinki University in the field of STEM education. Currently she works as a researcher at Aalto University, Department of Computer Science and Engineering. She has over 13 years work experience at the university including teaching and doing research both in Finland and abroad at research intensive universities.

Päivi's research interests include challenges in computing and engineering education. Her research projects aim to gain a holistic understanding of the instructional process, to locate the challenges, and to provide knowledge to systematically develop teaching so that students could gain better learning outcomes. In her studies Päivi approaches the challenges of the instructional process from the viewpoint of educational science thus bringing additional strength to otherwise more technically oriented LeTech research group. Her current research projects include students' first year experiences at the university including challenges relating to retention, and academics' perceptions of MOOCs (Massive Open Online Courses).

Talk 1: What students expect to study in CS degree?

I will discuss the research design and methods we have used in a multi-national research project on CS students' experiences of their first study year. I will give examples of the types of data we have and how we have analysed it. Finally, I will highlight some of the challenges of a multi-national research project.

Talk 2: Research methods and designs in computing education research.

In this talk I'll summarize some the results of a study on research papers in Engineering Education research (EER) field. The results highlight what kind of research strategies, data sources, and data analysis methods are often used in published EER papers.

NEW COMPUTER SCIENCE AND COMPUTING CURRICULA IN SCHOOLS – WHAT PERSPECTIVES SHOULD WE RESEARCH AND HOW?

Passey Don



Don Passey is Professor of Technology Enhanced Learning, Director of the Centre for Technology Enhanced Learning and Director of Studies for the Doctoral Programme in e-Research and Technology Enhanced Learning in the Department of Educational Research at Lancaster University, UK.

As Director of Studies for the Doctoral Programme, Don is responsible, with his team of tutors, for some 100 doctoral students who are undertaking their studies worldwide, all supervised and supported largely online, at a distance.

Don is a long-standing member of the international community of IFIP (the international federation for information processing), and he is currently vice-chair of the IFIP Technical Committee 3 on education, and Working Group 3.7 which focuses on information technology in education management. He received the Outstanding Service Award from IFIP for his work with the community, and is often asked to present at national and international events.

His research interests

Don's research interests span uses of emerging and blended digital technologies to support teaching and learning, in compulsory education, across the lifespan, and focusing on those who find it hard to learn, and those moving through transitions to employment and training. He has particular interest in how digital technologies support the processes of and the management of learning, and how these can be studied using mixed methods and bespoke approaches. He has a keen interest in how data and data management in education can be developed to support teacher and learner needs.

His presentation session

Don's presentation is entitled: *New computer science and computing curricula in schools - what perspectives should we research and how?*

In this presentation, Don will explore the reasons why computing curricula have been introduced into compulsory education, not only in England but in other countries, and the implications for research in this field. He will explore: the importance of applying different methodological approaches according to the focus of studies in this field; ways that research has already approached this field; the role that research should play over the next 10 years; the gaps in our research understanding that currently exist; and the opportunities this provides for researchers, while considering the fundamental challenges these create in research design.

WHAT CHARACTERISES ENGINEERING EDUCATION?

Pears Arnold



Dr. Arnold Pears is Associate Professor, Deputy Head of Department and Head of Education at the IT Department of Uppsala University, SWEDEN. He leads the UpCERG research group in Computing and Engineering Education at Uppsala University. He is also a Director of the CeTUSS Swedish National

Center for Student and Societally Relevant Engineering Education, Chair of the Strategic Advisory Board of the Uppsala University Center for STEM Higher Education Research, and a member of the Uppsala University Academic Senate, and the pedagogical advisory board to the Faculty of Science and Technology at Uppsala University.

Arnold received his BSc(Hons) and PhD from La Trobe University, Melbourne, AUSTRALIA. Arnold is an IEEE Senior Member and has

received the Computer Society Golden Core Member award (2012) and the Schmitz Award (2012) for services to the Computer Society and its conferences. He has published more than 100 articles and papers in major conferences and journals in Computer Science, Computer Engineering and Computing and Engineering Education and has served as conference and program committee chair for many major conferences under the auspices of the IEEE and ACM.

Presentation Abstract

Research questions in STEM disciplines are frequently strongly contextualised in the teaching and learning practice of the researcher. In this paper we chart a number of possible paths a researcher can follow from a single research proposition, or fundamental research question, to results which can vary significantly in nature. In order to do this, we establish a theoretical framework for research activity and examine the meaning of “theory” as a cognitive and research tool that helps engineering education practitioners and researchers. The paper reflects on the nature and role of different types of theory at four distinct stages of engineering education research: disciplinary, methodological, analytical, and interpretive. We illustrate how theory applies to the framing and integration of study results, and assists in the process of relating theories of learner development and learning to results of empirical data analysis.

Dagienė Valentina



Prof. Dr. Valentina Dagienė is principal researcher and head of Department of Mathematics and Informatics Institute at Vilnius University. She is supervising doctoral students in fields of informatics, informatics engineering and computer science education. The interests include computer science (informatics) teaching and learning strategies, puzzle-based learning, intelligent technologies for education, learning personalisation, semantic web applications. She published over 200 research papers and methodological works, wrote more than 50 textbooks in the field of informatics for schools. She has been working in various expert groups and work groups, organizing the olympiads in Informatics among students, also engaged in e-learning and problem solving. She is an Executive Editor of international journals "Informatics in Education" and "Olympiads in Informatics". She got the Lithuanian Science Award for cycle of works (2008), the ETH (Zurich, Switzerland) honorary gold medal for contributions to school informatics in Europe (2011) and the Informatics Europe 2015 Best Practices in Education Award for the Bebras.

Gunčaga Ján



Ján Gunčaga is Associated Professor of Mathematics Education at the Faculty of Education of the Catholic University in Ružomberok. He finished master study in Teaching of mathematics and physics at secondary school at Faculty of Mathematics and Physics, Comenius University in Bratislava (1997). He continued the study at the Faculty of Science Constantine the Philosopher University in Nitra in the doctoral study (PhD.) in Didactics of Mathematics (2004). Habilitation in Mathematics Education was at Faculty of Science and Technology of the University of Debrecen (2010). His interest is oriented now in mathematics education for primary and secondary level, history of education and using ICT in educational process.

Juškevičienė Anita



Dr. Anita Juškevičienė is junior researcher at the Vilnius University Institute of Mathematics and Informatics. During the period of 2009–2013, she was a PhD student at the Vilnius University Institute of Mathematics and Informatics (technological sciences, informatics engineering). The areas of her scientific interest are technology enhanced learning, intelligent and adaptive systems, recommender systems, semantics and ontology, evaluation of quality of learning software and learning process. She has been working very active on several national projects, helps to organize seminars and conferences. She has published a number of scientific papers and publications in popular magazines, participated in a number of large scale EU-funded R&D projects.

Kurilovas Eugenijus



Eugenijus Kurilovas is Senior Research Scientist at Vilnius University Institute of Mathematics and Informatics and Associate Professor at Vilnius Gediminas Technical University. He holds PhD in Informatics Engineering. His research interests focus on technology enhanced learning. He has published over 100 scientific papers, 2 monographs, and 4 chapters in scientific books. He is reviewer and member of over 30 editorial boards and programme committees of international scientific journals (incl. 13 indexed / abstracted in Thomson Reuters Web of Science) and conferences (incl. 7 indexed / abstracted in Thomson Reuters Web of Science). He has also participated in over 30 large scale EU-funded R&D projects, as well as in several international research studies such as STEPS, SITES, and ICILS. E. Kurilovas is honoured as TOP 100 Scientist – 2014 and 2015 by International Biographical Centre (IBC), Cambridge. His biographical records are included in: (1) Who's Who in the World – 2014, 2015 and 2016 (31st, 32nd and 33rd Editions); (2) 2000 Outstanding Intellectuals of the XXth Century – 2014 (8th Edition); (3) Who's Who in Science and Engineering –

2016-2017 (12th Edition), and (4) Dictionary of International Biography – 2014 and 2015 (37th and 38th Editions).

Main research area is technology-enhanced learning (e-learning):

- Intelligent technologies for education and learning personalisation: multiple criteria decision making; Semantic Web applications; intelligent agents etc.
- Mobile technologies in education
- Interoperability of e-learning system components: learning objects, repositories, activities, virtual learning environments etc.

Monga Mattia



I hold a PhD in "Computer and Automation Engineering" from Politecnico di Milano and I am currently an Associate Professor at Università degli Studi di Milano, Milan, Italy (Department of Computer Science). My research interests are mainly in the field of software engineering and security, but I'm pretty convinced that informatics is often misunderstood by the general public and especially in primary and secondary schools. I believe it is urgent to change this misperception, as it has negative impacts on the development of discipline and our society. To this end, I'm one of the founders of Aladdin, a group who works to spread the discipline of informatics among the general public, and I help in organizing a game-contest for schools called Bebras.

Pozdniakov Sergej



Education Undergraduate, postgraduate, Department of Algebra, Faculty of Mathematics and Mechanics, Leningrad university. Candidate degree in methodology of mathematics 1986 (Moscow). Candidate thesis title: "Methodology of teaching mathematics in professional schools". Doctor degree in theory and methodology of mathematics and computer science 1999 (Moscow). Doctor thesis title: "The modelling of information environment as technological base for teaching mathematics". Basic specialty: the mathematician - theory and methodology of teaching in mathematics.

Have more than 100 scientific publications, among them monography "Information environment for education" and "Generation of mathematical problems and verification of their solutions". Basic specialty: the mathematician - theory and methodology of teaching in mathematics. Teaching courses for university students: "Discrete Mathematics", "Mathematical Logic", "Theory of Algorithms", "Construction of Computer Programs for Education", "Information Technologies in Mathematics", "Models of Intellectual Processes". Teaching courses for school teachers: "Computer Tools in Math Teaching", "Internet Support of School Teachers", "Methodology of Using Computer for Supporting of Math Education". Teaching posts 1979-1982 assistant of the Chair of Mathematics of Khabarovsk Polytechnic Institute 1982-1985 teacher of mathematics and computer science in professional schools since 1986 associate professor of the Department of Mathematics of the St.-Petersburg, University of Electrical Engineering. since 1999 full professor of the Department of Mathematics of the St.-Petersburg, University of Electrical Engineering.

SUMMARIES OF STUDENTS

GAMIFICATION METHODS TO TEACH INFORMATICS ENGINEERING

Beresnevičius Gytautas

1 year of doctoral studies
VU MII, IMS PhD of informatics engineering
Address: M. Pretorijaus 7-16, Vilnius, LT-06227, Lithuania
gytber@gmail.com

Brief Biography

Information about me

Name: Gytautas
Surname: Beresnevičius
Date of birth: 1986-03-08
Address: M. Pretorijaus 7-16, Vilnius
Email: gytber@gmail.com
Mother tongue: Lithuanian

Work experience

| | |
|--------------------------------|--|
| 2008-01 and up until now | Mathematics tutor (self – employer, working on license) I teach mathematics for various class pupils, and various course students. |
| From 2012-12 until 2013-06-28: | Mathematics tutor at the VŠĮ “Arvydo švietimo ir mokymo centras” I taught 12-th class pupil mathematics privately at this school of private tutors. |

Education and achievements in science

| | |
|-----------------------------------|---|
| From 2015-10-01 until now: | I am studying PhD of informatics engineering in MII (Institute of Mathematics and Informatics) VU (Vilnius University) in 1 course. |
| From 2013-09-01 until 2015-06-22: | I received a master cum laude diploma of Education of Mathematics and Informatics at the MIF (Faculty of Mathematics and Informatics) VU. |
| From 2012-09-14 until 2012-09-16: | I participated in “Geogebra” conference in Estonia (Tartu) |
| From 2011-09-30 until 2011-10-02: | I participated in “Geogebra” conference in Lithuania (Vilnius) |
| From 2008-09-01 until 2013-06-27: | I received bachelor diploma of Mathematics’ and Informatics’ Teaching at the MIF VU. |
| From 2006-09-01 until 2008-06: | I was studying Psychology at Mykolas Romeris University. |
| From 2005-09-01 until 2006-06: | I was studying Mathematics and Applications of Mathematics at MIF VU. |
| From 1993-09-01 until 2005-07-07: | I received a graduation certificate of 12-th class at the Vilnius Gabija gymnasium. |
| From 2003-10-01 until 2005-04-02: | I received a graduating certificate of Lithuanian Youth Mathematics at the VU. |
| 2004-04-27: | I got a Physics honor certificate of Physics Olympiad of Vilnius city at 11-th class. |

Languages (in 10 points evaluating system)

Lithuanian is my mother tongue language.

| Language | Speaking | Understanding | Writing |
|----------|------------------|------------------|----------------|
| English | excellently (10) | excellently (10) | very well (9) |
| German | moderately (7) | moderately (7) | moderately (7) |

Research area description

The main problem is how to find valid and useful method of gamification to teach informatics engineering and adapt program code of education games for mobile phones, tablets and personal computers as well as for majority browsers.

The aim of research is to find useful and educating method of gamification, which will allow students to learn informatics engineering.

A presentation of preliminary ideas

I was interested in computer science, especially in some applications of programming languages that allows producing dynamic programs on the internet on browsers. I became interested in creating websites when I created my first website after I finished IT subject on my bachelor studies.

Educational games (sometimes called serious games) are games, which educate skills or improve knowledge of one or more kind of science area (such as mathematics, computer science, and physics). Nowadays majority pupils and students use web browsers to entertain themselves on their free time. It is good thing not only to be entertained, but also at the same time learn some useful knowledge or acquire skills in computer science. One aspect of informatics engineering is that people apply computer science knowledge and skills to obtain some kind of science area.

One of my new interests is creating educational games. Gamification is the application of game-design elements and game principles in non-game contexts. It attempts to improve user engagement, organizational productivity, flow, learning and some other factors. I would like to create or at least explore, and determine valid model of gamification that allows learning informatics engineering. I am going to explore literature of computer science applications, search for methods of gamification which produce high results of acquiring computer science knowledge and skills playing educational games.

As I am studying informatics engineering, I want to apply computer science to create educational games, which will help to learn informatics engineering and students will be probably think how to apply computer science in some kind of game-based environment that will work on browser in my website. This also should be applied for mobile phones as well as for tablets and ordinary personal computers.

I used to program with JavaScript, CSS, HTML, PHP to create my website. JavaScript, HTML5, CSS are often used programming languages to create games on websites. Python programming language is also very popular for creating games on the internet. So maybe I will use combinations of these mentioned programming languages to produce dynamic educational games and apply model of gamification to achieve good results for teaching informatics engineering.

Educational games improve cooperating, where players communicate with friends, who play the same game at the same time. It also improves logic thinking, helps to understand principles of the science, which game educates the student. (Andreas Schäfer, 2013).

Now I have just begun reading and analyzing articles and books about gamification and JavaScript programming language to create games.

Expectations and motivation to attend Doctoral Consortium

I want to participate in Doctoral Consortium, because I want to know about applications of computer science and teaching practice of other more experienced lecturers, assistant professors, professors, and PhD students' works, articles and plans what they intend to write, especially if it is concerned on computer science applications.

I expect interesting discussions; work in small groups and useful lectures.

Literature

1. Andreas Schäfer , Jan Holz , Thiemo Leonhardt , Ulrik Schroeder , Philipp Brauner & Martina Ziefle (2013) " *From boring to scoring – a collaborative serious game for learning and practicing mathematical logic for computer science education*, *Computer Science Education*", 23:2, 87-111, DOI: 10.1080/08993408.2013.778040 , <http://dx.doi.org/10.1080/08993408.2013.778040> .
2. Lasse Hakulinen. „*Gameful Approaches for Computer Science Education From Gamification to Alternate Reality Games*“, (2015 y.), Helsinkis, Suomija
<https://aaltodoc.aalto.fi/bitstream/handle/123456789/15756/isbn9789526061733.pdf?sequence=1>
3. Rex van der Spuy. “*Foundation Game Design with HTML5 & JavaScript*” (2012 y.),
<https://retrosnob.files.wordpress.com/2014/10/foundation-game-design-with-html5-and-javascript-v413hav-1.pdf> .
4. Al Sweigart. “*Invent Your Own Computer Games with Python, 2nd Edition*” (2012 y.),
<https://inventwithpython.com/inventwithpython.pdf> .

DESIGN AND DEVELOPMENT OF CONSTRUCTIVISTS LEARNING OBJECTS FOR THEORETICAL COMPUTER SCIENCE AND SCIENTIFIC COMPUTING EDUCATION

Dolgopolas Vladimiras

2 year doctoral student
VU Institute of Mathematics and Informatics,
Informatics methodology department
Akademijos g. 4
LT-08663 Vilnius, Lithuania
vdolgopolas@gmail.com

Supervisor prof. Valentina Dagienė

Background and research area description

This is an interdisciplinary research which focuses on applications of constructivists teaching and learning theories and methods to theoretical computer science, scientific computing and computer algebra education. All of the above-mentioned educational disciplines could be considered as a part of an advanced computer science (CS) education curriculum, thus motivating the researcher's efforts looking for a common approach, methods and constructing a unifying educational framework which is intended to be based on constructivist learning and teaching paradigms.

Constructivist and Constructionist approaches to learning

We start from the general approach of constructivism in education. Constructivism is a theory of knowledge that argues that humans generate knowledge and meaning from an interaction between their experiences and their ideas [1]. Von Glasersfeld [2] describes Constructivism as “a theory of knowledge with roots in philosophy, psychology, and cybernetics. It asserts two main principles whose application has far-reaching consequences for the study of cognitive development and learning as well as for the practice of teaching, psychotherapy, and interpersonal management in general. The two principles are: (1) knowledge is not passively received but actively built up by the cognizing subject; (2) the function of cognition is adaptive and serves the organization of the experiential world, not the discovery of ontological reality.” These principles are of primary importance for the purpose of our study. To support an active buildup of the knowledge, we need appropriate learning objects to be constructed. Caine and Caine [3] in their fundamental research propose the main principles of constructivist learning. One of the most important for us is as follows: “The brain processes parts and wholes simultaneously”. So, a well-organized learning process provides details as well as underlying ideas. Using model-centered learning, we introduce the goal of the research after the learner experiments with the model for simulation. That allows us to observe the results and to draw relevant conclusions. Constructivism advocates student-centered, discovery learning where students use information they already know to acquire more knowledge [4].

Constructionism [5] and constructionist learning is inspired by the constructivist theory specifying how individual learners construct mental models in order to understand the world around them. Constructionism provides us a basic idea of an appropriate learning object. Such an object should support step by step understanding of the materials and concepts it represents, allowing user to self-construct his or her knowledge.

Applications of Constructivism and Constructionism approaches to programming education

In his research [6], Ben-Ari develops a constructivist methodology for computer science (CS) education. The author stresses an idiosyncratic version of knowledge each student constructs basing on knowledge the students already has. Here is very important to show the difference between classical and constructivist educational paradigm. As classical paradigm, among others theoretical statements, describes a student as a “clean mind” and tries to fill it (his mind) with the particular knowledge, constructivist paradigm consider any student's previous experience (knowledge) as a main part of an educational process, stressing that a new knowledge could be only build “on the top” of the previous

one and only by the student itself. So an active learning must take place [6]: “Passive learning will likely fail, because each student brings a different knowledge framework to the classroom, and will construct new knowledge in a different manner. Learning must be active: the student ‘must construct knowledge assisted by guidance from’ the teacher and feedback from other students”. So the task of the educator is to develop the learning process in a manner which supports student’s knowledge self-construction with an emphasis on the student’s previous background (mental model) existence or non-existence.

Wulf [7] reviews “the application of constructivist pedagogical approaches to teaching computer programming in high school and undergraduate courses.” The author stresses an importance to communicate with students explaining the principles of constructivist approach to learning. Students, who are not familiar with constructivist approach, usually complain about the lack of explanations from the teacher’s side. Here it is important to motivate the student by involving him or her to the teaching process by providing an appropriately designed learning object.

Several additional remarks could be done here [6]. First, if we accept a constructivist approach to programming education, the appropriate “level” of the basic mental model is an essential for successful further education, so the model-centered approach could serve us in our didactical constructions. Second, we must avoid the so called “bricolage”, a term coined by Claude Levi-Strauss and adopted for the needs of teaching programming by Turkle and Papert [8]. The bricolage leads to the “endless debugging of the ‘try-it-and-see-what-happens’ variety” [6], so - an appropriately designed learning object must take care of this issue. In such a case, the model-centered approach could serve us as well. The basic model, which lies in the “center” of the learning object, will “protect” the student from the unlikely bricolage side-effects.

Hadjerrouit [9] investigates a constructivist approach to practical software engineering lecturing and presents a case study of practical examples of constructivist approach to teaching object programming and using web-based resources for the course. It is obvious that constructivist approach should be supported by appropriate and properly designed learning objects which support the constructivist paradigm.

Teaching scientific computing

Scientific computing plays an important role in science and engineering education. World leading universities and organizations pay an increasing attention to the curriculum and educational methods. Allen et al. report on a new graduate course in scientific computing that was taught at the Louisiana State University [10]. “The course was designed to provide students with a broad and practical introduction to scientific computing which would provide them with the basic skills and experience to very quickly get involved in research projects involving modern cyber infrastructure and complex real world scientific problems.” Within the scope of our study, we understand the meaning of “scientific computing” as using computers to analyze and solve scientific and engineering problems. We distinguish that from pure numerical computations.

One of the tasks in the scientific computing education is to provide a general understanding of solving scientific problems. M.T. Heath [11] writes, “. . .try to convey a general understanding of the techniques available for solving problems in each major category, including proper problem formulation and interpretation of results. . .”. He offers a wide curriculum to be studied including a system of linear equations, eigenvalue problems, nonlinear equation, optimization, interpolation, numerical integration and differentiation, partial differential equations, fast Fourier transform, random numbers, and stochastic simulation. All these topics require a large amount of computations and could require parallelization solutions to be solved.

Studying scientific computing is always a challenging task for the learner as well as for the educator. Such a studying process deals with plenty of technical and multidisciplinary issues and requires a synchronization of the learner’s mathematical and computer science competencies. To overcome these difficulties, a set of learning objects and the relevant methodology could be developed. This should be based on a constructivist approach to learning and should provide a relevant framework for the educator and appropriate learning material to students. Such a framework should enable the learner to conduct a series of computational experiments with computer models. Using such an approach, related mathematical and programming knowledge is provided on demand and parallel to the main curriculum. We consider a computational statistics or analogic sections of the introductory scientific computing course as possible application scope of this approach. Karniadakis and Kirby II define [12] “scientific

computing is the heart of simulation science”. The authors offer a “seamless approach to numerical algorithms, modern programming techniques, and parallel computing. . . . Often times such concepts and tools are taught serially across different courses and different textbooks, and hence the interconnection between them is not immediately apparent. The necessity of integrating concepts and tools usually comes after such courses are concluded, e.g. during a first job or a thesis project, thus forcing the student to synthesize what is perceived to be three independent subfields into one in order to produce a solution. Although this process is undoubtedly valuable, it is time consuming and in many cases it may not lead to an effective combination of concepts and tools. Moreover, from the pedagogical point of view, the integrated seamless approach can stimulate the student simultaneously through the eyes of multiple disciplines, thus leading to enhanced understanding of subjects in scientific computing”. Figure 1 presents the definition of scientific computing as an intersection of numerical mathematics, computer science and modelling [12].

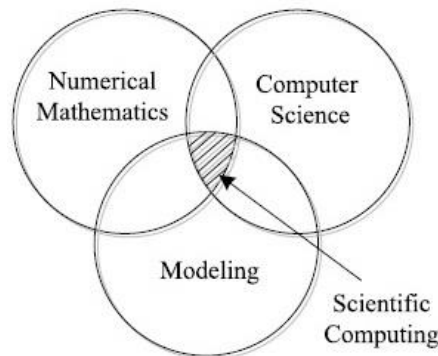

Figure 1. Scientific computing.

A presentation of any preliminary ideas, the proposed approach and achieved results

We propose a **model centered approach** for the purpose of constructing of the relevant learning objects and educational frameworks. The model centered approach was introduced by A. S. Gibbons as Model - Centered Instruction in 2001 [13]. For us the following main principles are important:

- Learner’s *experience* is obtained by interacting with models;
- Learner solves scientific and engineering *problems* using simulation on models;
- Problems are presented in a constructed *sequence*;
- Specific instructional *goals* are specified;
- All necessary *information* within a solution environment is provided.

M. Millard, J.M. Spector and P.I. Davidsen [14] propose Model Facilitated Learning using “interactive simulations”. The authors present a modern computer technology powered by “promising methodology” based on “system dynamics”. “Supportable experiences include the construction of interactive ... models as well as their use *for hypothesis testing and experimentation*”.

R. Lehrer and L. Schauble [15] refer to the experiments with different representations of the model: “Student learning is enhanced when students have multiple opportunities to invent and revise models and then to compare the explanatory adequacy of different models”.

In the filed **scientific computing education** an approach of experiments with models is proposed by L. Xue et al. [16]. Authors introduce “teaching reform ideas in the “scientific computing” education by means of modeling and simulation”. Authors also suggest “...the use of the modeling and simulation to deal with the actual problem of programming, simulating, data analyzing...”. Model-Centered Learning is used in mathematics education. Plenty of models are constructed using “Geogebra” software [17]. Models play a central role in Science Education [18], [19].

As an example of the possible solution, we introduce an application of the model centered approach to the field of scientific computing education [20]. Such approach incorporate the constructivist learning ideas and also could be used as a platform for novice learning methodologies such as inverted leaning or lab based learning [21]. The set of programming models is proposed. The methodology is based on stochastic simulation of the provided model of the multiphase queueing system [22].

At the present time the next **research questions** are considered to be solved:

- What is the set of topics, methods, theoretical constructions and algorithms to be included in to the educational framework?
- In which way the relevant learning objects should be constructed?
- What are the basic requirements for the learner's background?
- What are the key instruments for modeling and experiments with models?
- What is the methodology of evaluation and testing?

The present task of the research is to investigate the theoretical computer science, scientific computing and symbolic computation algorithms and theoretical constructions. This will provide a basis for further developing of the methodology and constructivists learning objects based on computer mathematics models. **An overall research goal** could be described as follows. As a result of the research the proper learning framework and learning objects should be developed. The models of the main advanced programming constructions like parallel calculations, declarative programming and others which are based on constructivist learning approach must be designed. Under such approach the basic mathematical constructions are introduced in parallel with programming models. The next step is conducting of experiments with computer mathematics models, verifying theoretical mathematical results. This improves computer science and mathematical literacy. This is also provides an introduction for basic mathematical topics of various difficulty levels.

Expectations and motivation to attend Doctoral School

Expectations include the next ongoing research topics to be clarified with an assistance of thesis supervisor and invited researchers:

- the research methodology is needed to be clarified
- the field of the research is possibly needed to be narrowed
- the background theories are needed to be systemized
- the experimental activities should be clarified

Bibliographic References

- [1] Eddy, M.D., *Fallible or Inerrant? On the Constructivist's Bible*. British Journal for the History of Science, 2004. **37**: p. 93-98.
- [2] Glasersfeld, E.v., *Constructivism in education*. The international encyclopedia of education, 1989. **1**: p. 162-163.
- [3] Caine, R.N. and G. Caine, *Making connections: Teaching and the human brain*. 1991.
- [4] Alesandrini, K. and L. Larson, *Teachers bridge to constructivism*. The Clearing House, 2002. **75**(3): p. 118-121 %@ 0009-8655.
- [5] Papert, S. and I. Harel, *Situating constructionism*. Constructionism, 1991. **36**: p. 1-11.
- [6] Ben-Ari, M., *Constructivism in computer science education*. Journal of Computers in Mathematics and Science Teaching, 2001. **20**(1): p. 45-73 %@ 0731-9258.
- [7] Wulf, T. *Constructivist approaches for teaching computer programming*. 2005. ACM.
- [8]Turkle, S. and S. Papert, *Epistemological pluralism: Styles and voices within the computer culture*. Signs, 1990: p. 128-157 %@ 0097-9740.
- [9] Hadjerrouit, S., *Constructivism as guiding philosophy for software engineering education*. ACM SIGCSE Bulletin, 2005. **37**(4): p. 45-49 %@ 0097-8418.
- [10] Allen, G., et al., *A practical and comprehensive graduate course preparing students for research involving scientific computing*. Procedia Computer Science, 2011. **4**: p. 1927-1936 %@ 1877-0509.
- [11]Heath, M.T.X., *Scientific computing*. 2001: McGraw-Hill.
- [12] Karniadakis, G.E. and R.M. Kirby li, *Parallel scientific computing in C++ and MPI: a seamless approach to parallel algorithms and their implementation*. Vol. 1 %@ 110749477X. 2003: Cambridge University Press.
- [13] A. S. Gibbons, Model-centered instruction, Journal of structural Learning and Intelligent Systems (2001), no. 14, 511-540. 10
- [14] M. Milrad, J. M. Spector and P. I. Davidsen, "Model facilitated learning," Instructional design, development and evaluation, vol. 3, Syracuse University Press, 2003.
- [15] R. Lehrer and L. Schauble, "Cultivating model-based reasoning in science education," The cambridge handbook of the learning sciences, Cambridge University Press, 2005, pp. 371-388.

- [16] Xue, Lian, et al. "Modeling and Simulation in Scientific Computing Education." *2009 International Conference on Scalable Computing and Communications; Eighth International Conference on Embedded Computing*. 2009.
- [17] "Model-centered learning. Pathways to mathematical understanding using geogebra," *Modeling and simulations for learning and instruction*, vol. 6, Sense Publishers, P.O. Box 21858, 3001 AW Rotterdam, The Netherlands, 2011.
- [18] M. S. Khine and I. M. Saleh, *Models and modeling, cognitive tools for scientific enquiry*, *Models and modeling in science education*, vol. 6, Springer, 2011, p. 290.
- [19] J. Clement and M. A. Rea, *Model based learning and instruction in science*, vol. 2, Springer Netherlands, 2008.
- [20] Vladimiras Dolgopolas, Valentina Dagienė, Saulius Minkevičius, Leonidas Sakalauskas *Python for Scientific Computing Education: Modeling of Queueing Systems* *Scientific Programming*, IOS press, Amsterdam. ISSN: 1058-9244, 2014, vol. 22, no. 1/2014, p. 37-51.
- [21] Vladimiras Dolgopolas, Loreta Savulionienė, Valentina Dagienė *Enhancing Students' Motivation in the Inverted CS2 Course: a Case Study*, DOI: 10.13140/2.1.3086.7841 Conference: International conference on e-learning: e-Learning'14, At San Cristobal de La Laguna, Spain, 2014
- [22] Saulius Minkevičius, Vladimiras Dolgopolas, Leonidas Sakalauskas *A law of the iterated logarithm for the sojourn time process in queues in series* *Methodology and Computing in Applied Probability*, Springer Science+Business Media, New York. ISSN: 1573-7713, April 2014, URL: <http://dx.doi.org/10.1007/s11009-014-9402-y>

VISUAL LEARNING OBJECTS MODIFICATION RESEARCH TO PERSONALIZED LEARNING

Dvareckienė Viktorija

1st years PhD student
Vilnius University Institute of Mathematics and Informatics
Akademijos str. 4
Vilnius, LT-08663, Lithuania
viktorija.dvareckiene@gmail.com

Your Brief Biography

Prior studies:

- Bachelor Degree in Informatics (2011), Vilnius University, Lithuania;
- Master Degree in Mathematics (2013), Vilnius University, Lithuania;

Research area description

- The main problem you are trying to tackle and its relevance

Yet in Lithuanian high education every student are trained by a common method not according to their learning style. If we teach students according to their learning styles can be achieved greater results of learning.

The aim of research

To modify existing learning objects (LO) for students whose learning style is visual.

Research questions

1. How modify learning objects that they be adapted to students, whose learning style is visual?
2. How interactive and visual learning objects affect various forms of teaching and learning?
3. What level of interactivity should be used to improve learning outcomes?

- An outline of the current knowledge of the problem domain (What is the state-of-the-art in relation to existing solutions to the problem)

My research is based on Felder and Silverman learning Styles typology, which defines learning style and claims that each learner choose different learning strategies during learning.

In most classes very little visual information is presented: students mainly listen to lectures and read material written on chalkboards and in textbooks and handouts. Unfortunately, most people are visual learners, which means that most students do not get nearly as much as they would if more visual presentation were used in class. Good learners are capable of processing information presented either visually or verbally.

Students learn in many ways— by seeing and hearing, reflecting and acting, reasoning logically and intuitively, memorizing and visualizing and drawing analogies and building mathematical models, steadily and in fits and starts. Teaching methods also vary. Some instructors lecture, others demonstrate or discuss, some focus on principles and others on applications, some emphasize memory and others understanding. How much a given student learns in a class is governed in part by that student's native ability and prior preparation but also by the compatibility of his or her learning style and the instructor's teaching style.

Felder-Silverman (1988) learning-style model classifies students according to where they fit on a number of scales pertaining to the ways they receive and process information (Figure 1). A model intended to be particularly applicable to engineering education is proposed below. Also proposed is a parallel teaching-style model, which classifies instructional methods according to how well they address the proposed learning style components.

The ways people receive information may be divided into three categories, sometimes referred to as modalities: visual—sights, pictures, diagrams, symbols; auditory— sounds, words; kinesthetic—taste, touch, and smell. An extensive body of research has established that most people learn most effectively with one of the three modalities and tend to miss or ignore information presented in either of the other

two. There are thus visual, auditory, and kinesthetic learners. Visual learners remember best what they see: pictures, diagrams, flow charts, time lines, films, demonstrations. If something is simply said to them they will probably forget it.

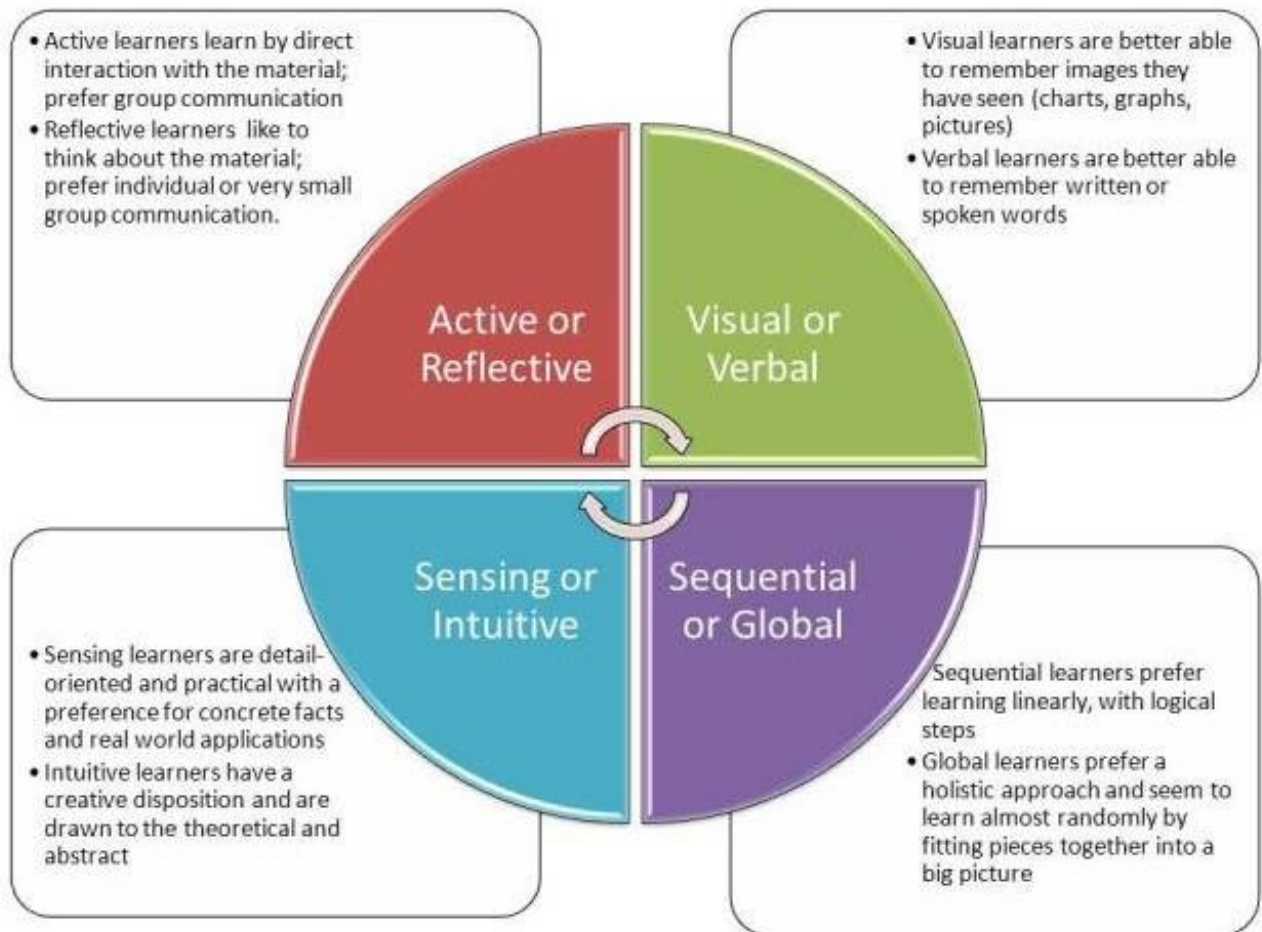

Figure 1. Description of Felder-Silverman Learning Style Dimensions.

- Advances beyond the state-of-the-art in terms of your specific contribution and research plan (A description of the Ph.D. project's contribution to the problem solution)
 - The current educational scenario, objects and the development of technology modification research.
 - To perform applied research and prepare solutions for the lifecycle of learning objects personalized in informatics engineering.
 - Set (identification) scientific problems arising from the tasks related to visual learning objects simulation and modification to personalize learning.

A presentation of any preliminary ideas, the proposed approach and achieved results

- Current status of the research plan
 - Research just started. Literary analysis, research analysis and technology analysis are used for understanding of existing situation in the world and for finding the best solutions.
- A sketch of the applied research methodology (data collection and analyzing methods)
 1. Literature analysis.
 2. Qualitative research methodology
 - a) observation,
 - b) notes,
 - c) interview,
 - d) Artefacts, photos, video.

Bibliographic References

1. Richard M. Felder, Linda K. Silverman (1988). Learning and Teaching Styles In Engineering Education. *Engr. Education*, 78(7), 674–681 (1988).
2. Valentina Dagienė, Eugenijus Kurilovas. Design of Lithuania digital library of educational resources and services: the problem interoperability. *ISSN 1392 – 124X Information Technology and Control*, 2007, Vol.36, No.4.
3. Hazra Imran, Mohammad Belghis-Zadeh, Ting-Wen Chang, Dr Kinshuk, Sabine Graf. PLORS: a personalized learning object recommender system. *Vietnam Journal of Computer Science* 08/2015; doi: 10.1007/s40595-015-0049-6
4. Richard Felder. Resources in science and engineering education.
http://www4.ncsu.edu/unity/lockers/users/f/felder/public/Learning_Styles.html

Expectations and motivation to attend Doctoral Consortium

In international doctoral consortium: gain new knowledge and skills, networking, sharing ideas, group work, common research activities.

ELABORATION OF PREPARATION SYSTEM FOR IT TALENTS

Erdősné Németh Ágnes

Third semester of overall six semesters

Eötvös Loránd University, Faculty of Informatics, PhD School – Batthyány Lajos Gimnázium

Pázmány Péter sétány 1/C.

Budapest, 1117, Hungary

agi@microprof.hu

Brief Biography

I am a teacher of informatics and mathematics in a high school in a medium-size town (50000 inhabitants) in south-west Hungary. I have been teaching there for nine years. Before that I worked as a computer programmer and as a part-time teacher at university. In my school there are classes for children from the age of 10 till 18 (grade 5 till 12) and other classes for children from the age of 14 till 18 (grade 9 to 12). It is a secondary grammar school, which prepares children for further education. When I started teaching there, there were no students from my school at competitions of informatics.

I have built a system for pupils talented in IT (and math) during these nine years. This system is very efficient and unique not only in Hungary but maybe internationally as well. Its efficiency can be proved by the results of the students:

- every year there are 8-10 pupils of mine in the final round of Hungarian LOGO programming contest, it has been won by my students seven times (this is for students of the age of 10-15);
- every year 8-12 students of mine are in the finals of Nemes Tihamér Programming Contest (out of the 50 participants of the final round, this is for the age of 12-16);
- last two years 4 of my students were finalists at the National Olympiad in Informatics and one of them won this competition last year;
- in the last years some students of mine were invited to the selection process for International Olympiads;
- in 2015 one of my students has won a silver medal at the International Olympiad in Informatics.

The uniqueness of the system is that I work at the same place and same time together with children who are at very different levels of informatics knowledge and are of a wide range of ages. They work on nearly the same exercises individually or in small groups. The task descriptions are almost the same, but there is a little change which causes a huge difference in the thinking and solution methods. They can help each other – sometimes the younger students with more experience help the older ones, who have less knowledge. Working in such a various age and divers knowledge group creates a very inspiring environment for the members, but it needs very sophisticated preparing from the teacher and a very strong cooperation between teacher and students. I use the Internet, on-line preparation and contest sites a lot in the preparation process.

Publications

1. Erdősné Németh Ágnes (2015) Introducing recursion with LOGO in upper primary school *The Proceedings of International Conference on Informatics in Schools: Situation, Evolution and Perspectives — ISSEP 2015.Ljubljana* pp. 121-129.
2. Erdősné Németh Ágnes, Dr. Zsakó László Online training and contests for informatics contestants of secondary school age *EDUKACJA TECHNIKA INFORMATYKA / EDUCATION TECHNOLOGY COMPUTER SCIENCE (ISSN: 2080-9069) 11: (1)* pp. 273-280. (2015)
3. Nevena ACKOVSKA, Ágnes Erdősné Németh, Emil Stankov, Mile JOVANOVIĆ (2015) Report of the IOI Workshop “Creating an International Informatics Curriculum for Primary and High School Education” *OLYMPIADS IN INFORMATICS 9* pp. 205-212.
4. Erdősné Németh Ágnes (2015) Egy feladat megközelítése több szinten *DOSZ Tavasz szél Publio Kiadó, 2015.* p. 161-169.(ISBN:978-963-397-702-6)
5. Erdősné Németh Ágnes(2014) Programozási versenyekre készülés online lehetőségei *INFODIDACT Budapest, Webdidaktika Alapítvány Paper ENA.pdf.* 11 p. (ISBN:9789631206272)
6. Erdősné Németh Ágnes (2010) Síklefedések *ZALAMAT Általános és középiskolai matematikai tehetséggondozás: feladatsorok szakköri munkához.* pp. 136-141. (ISBN:978-963-88350-1-7)

Research area description

Key points of my research:

- Make an overview of the national and international talent management in informatics: analysis, comparison.
- Find principles and methods of effective talent management (competitions, courses, camps, online courses, online bank of tasks, online competitions).
- Place an IT talent management system in public education. Examine international connections.
- Design a new curriculum for the talented with strong methodology.

A presentation of any preliminary ideas, the proposed approach and achieved results

One and a half year ago I began my doctoral studies at the Doctoral School of informatics Faculty of Eötvös Loránd University. I work at the Department of Media and Educational Informatics on my PhD.

In the first year I read a huge amount of papers about teaching informatics, especially selecting and teaching talented students, preparing them for IOI. I read articles about algorithms used in competitions and about different methodologies to teach programming from:

- IOI Journal – Olympiads In Informatics, http://www.ioinformatics.org/oi_index.shtml
- Informatics in Education, http://www.mii.lt/informatics_in_education/contents.htm
- Acta Didactica Napocensia, <http://adn.teaching.ro/>
- Teaching Mathematics & Computer Sciences, <http://tmcs.math.klte.hu/>
- and proceedings of conferences, like ISSEP, ECSS, DIDMATTECH, MIDK

In the second and third semester I gathered information about the current state of IT talent programs and resources of Hungary: competitions, courses, summer courses, learning materials, selection processes, “best practices” of teachers. I made an overview about the mathematical talent programs, what are the possibilities of the gifted children from math. My next (unpublished) article is about what mathematical and IT skills are required for the national LOGO competition: what mathematical knowledge is used in the LOGO competition tasks and how the problem-solving in LOGO can help at mathematics lessons. I made an overview of international preparation and contest sites, analyzing which one is good for what. My next step is to examine connection between public education and the courses for talented, especially the problem-solving and computational thinking part.

Next semester, the aim is to look out for international IT talent management. I want to examine the selection process of IT talents and the preparation process for IOI in different countries. Next step is comparing the Hungarian IT talent management and other national systems: to analyze the advantages and disadvantages of different systems. Last but not least I would like to develop a new adaptable system.

Bibliographic References

1. Szlávi P., Zsakó L. *Methods of teaching programming* Teaching Mathematics and Computer Science 1, No. 2, 247-258, 2003.
2. Péter Szlávi, László Zsakó *Key concept in informatics: Algorithms* Acta Didacta Napocensia, Vol 7, No 1, 2014
3. Péter Szlávi, László Zsakó *ICT competensia: Algorithmic thinking* Acta Didacta Napocensia, Vol 5, No 2, 2012
4. Pohl W. (2006), *Computer science contests for secondary school students: approaches to classification*. Informatics in Education, 2006, Vol 5, 125–132.
5. Combéfis S., Wautelet J. (2014), *Programming Trainings and Informatics Teaching Through Online Contests*. Olympiads in Informatics, 2014, Vol. 8, 21–34.
6. Forišek, M. (2013), *Pushing the boundary of programming contests*. Olympiads in Informatics, 2013, Vol. 7, 23–35.
7. G. Cuba-Ricardo, P.A. Leyva-Figueroa, L.L. Mendoza-Tauler (2014), *Learning Strategies of Informatics Contestants*. Olympiads in Informatics, 2014, Vol. 8, 35–48.
8. M. Hiron, L. Février (2012), *A Self-Paced Learning Platform to Teach Programming and Algorithms*. Olympiads in Informatics, 2012, Vol. 6, 69–85.

9. Ragonis N. (2012), *Type of questions – the case of computer science*. Olympiads in Informatics, Vol. 6, 115–132.
10. Garcia-Mateos, G., Fernandez-Aleman, J.L. (2009), *Make learning fun with programming contests*. Transactions on Edutainment II. Lecture Notes in Computer Science 5660, 246–257.
11. J. M. Wing: *Computational thinking*, In: Communications of the ACM, 49(3), p. 33-35, 2006. <https://www.cs.cmu.edu/~15110-s13/Wing06-ct.pdf>
12. Juraj Hromkovic *Algorithmic Adventures – From Knowledge to Magic* Springer, 2009.

Expectations and motivation to attend Doctoral Consortium

On the consortium I hope to meet professors and other doctoral students who work on developing curricula, some of them working with very talented students and can recommend me some useful sources and ideas to do my research. I need an outlook on international IT talent management. I need some ideas on how I can collect information about talent selection, preparing process and the connection with the public education systems.

The next semester's aim in my doctoral studies is to examine the talent management systems of other countries. The literature about the methods and curricula is weak, so I think I have to ask the teachers, who are in the process of preparing students, directly. I hope I will have some direct contacts to them from the participants of the doctoral consortium.

And, of course, I hope to be in a friendly environment on the consortium, and to receive new ideas and strong motivation to keep on working.

SUSTAINING COMPUTER SCIENCE COMPETENCES IN ITALIAN SECONDARY SCHOOLS

Giaffredo Silvio

Second Year of doctoral studies
Department of Information Engineering and Computer Science (DISI) - University of Trento
v. Sommarive, 9
Trento, 38123, ITALY
silvio.giaffredo@unitn.it

Brief Biography

Silvio Giaffredo (1960) received the degree in Economics and the Diploma of the Special School in Informatics by the University of Trento, Italy. He worked in a software house, then in high schools as a computer science teacher for 21 years. His interests are on finding effective ways to teaching and learning informatics at the upper secondary school levels. At the moment, investigating around the discipline-specific competences seems to be a good starting point.

Publications:

- Wesselink, R., Giaffredo, S. (2015). Competence-based education to develop digital competence. In *Encyclopaideia*, vol. 19, n. 42, (pp. 25-42), 2015, ISSN 1590-492X , DOI: 10.6092/issn.1825-8670/5537
- Giaffredo, S., Mich, L., Ronchetti, M. (2015), Computer Science Competences in Italian Secondary Schools: a Preliminary Study. In *INTERNATIONAL Conference on Informatics in Schools, ISSEP 2015*, September 28 - October 1, Ljubljana, Slovenia (pp. 4-12). ISBN 978-961-6209-87-8 (pdf)
- Chiozzi, G., Giaffredo, S., Gris, R. & Ronchetti, M. (2014). Helping educators to teach competences with the support of technology in the Italian context. In *Proceedings of World Conference on Educational Multimedia, Hypermedia and Telecommunications 2014* (pp. 106-113). Chesapeake, VA: AACE.
- Giaffredo, S., Ronchetti, M., Valerio, A. (2014) Didattica per competenze: che supporto dalla tecnologia? In *DIDAMATICA Informatica per la Didattica Nuovi Processi e Paradigmi per la Didattica 28° EDIZIONE - ATTI*, Napoli: Aica, 2014 (p. 398-406). - ISBN: 9788898091317.

Research area description

- **(main problem ... and its relevance)** The competence-based education has been conceived as an effective approach to education, according to research and to the most important educational institutions. Many efforts have been done to bring this approach into real classes, but the few available data cannot confirm the expected success in applying it at school. We are trying to understand how Computer Science teachers could perceive the adoption of the competence-based approach as sustainable for their teaching. Our study is addressing both the project-based learning, an educational method compliant with the competence-based approach, and a different definition of the discipline-specific competences, involving the direct participation of the Computer Science teachers. Accordingly, we are conducting two experiments during a training course, developed as an action-research course for Informatics teachers of upper secondary schools. The research method and first qualitative result data are discussed here.

One of the first step used for implementing the competence-based approach to education, is to define (or agree on) a list of the competences which learners are planned to develop. For this reason, there are definitions of the competences in many areas, included Computer Science. Unfortunately, even the best definitions are sometimes not enough to produce an effective adoption of the approach. Are the definitions too far from daily classes, i.e. too abstract to be used? Are the teachers too far from the demanding requirements of the didactical research, i.e. too much involved in the ordinary activity, to be open for a wider vision of the teaching activity? Are there other reasons for that?

- **(aim of research)** The aim of the research is to create situations and opportunities for supporting teachers in their adoption of competence-based approach. We are working in two different

directions. By one side, we are studying a solution to sustain the Project-based Learning (PBL), a didactical method which is fitting the requirements of the competence-based approach and which is used by many computer science teachers. A training course, developed as an action-research activity, is the organisational framework in which we are building up several didactical project, implemented by the trainee (teachers) in their classes. By the other side, we will study the effects of a stronger engagement of the teachers into the process for the competences definition. To this purpose, some teachers will be involved in a situation capable to produce a shared definition of competences, for the discipline of Computer Science in specific class levels of the technical schools. The domain of the whole research is limited to the local area of Trentino province, and to the computer science education in the secondary technical schools.

- (**current knowledge of the problem domain + solutions' state-of-the-art**) The relevance of the concept of competence has been highlighted since the research of White [1], whereas in 1973 McClelland [2] deals with the issue of assessment in job recruitment, applying the idea of competence to the professional environment. From that beginning, many researches began to study how to apply the same insights of this approach to the education and during the Eighties, the vocational training system in UK started to adopt the competence-based approach. This experience has been criticised by some authors; for example, Hayland found that this system is “concerned only with the accreditation of performance outcomes, not with processes of learning and development” (see [4], p.495). During the more recent decades, many researchers have been studying how to apply the same insights of the competence-based approach to the general education, mostly in the formal situations, with the aim at obtaining better results for the students. Along with the general definitions, for example by the European Institutions [3], we have specific definitions by the educational institutions of the member countries, Italy included. In our country, in 2011 the Ministry for Education reformed the secondary schools, grouped into the three fields of general, technical and vocational education. The educational institutions proposed also to the teachers and to the schools a list of competences definitions. From the launch of the reform and till now, the application of these suggestions in the classes has not yet monitored by institutional survey and, as a consequence, there are no official data, referring if the competence-based approach has been adopted in real classes, and at which extent.
- (**your specific contribution and research plan**) We began our study trying to gather some relevance from the teaching activity, to understand if the competence-based approach by the teachers is as popular as by the researchers and by the institutions. To this purpose, we had a focus-group activity, realised with teachers of different subjects, and two different studies, specifically involving computer science teachers: individual interviews and a questionnaire on project-based learning. Even with a reduced quantity of data, the first results of our qualitative analysis say that the adoption of the competence-based approach is not as wide as national and local educational institutions could expect, after the definition of the normative competences. Then, found the gap between formal definition and practical usage, our research tries to suggest a solution to sustain the adoption of the competences, at least by the computer science teachers. To this aim, we are studying two different aspects of the situation, which are the goals of our research:

Goal 1 - a definition of the competences, suitable to the teaching activity and more acceptable by the teachers;

Goal 2 - a support for teachers, effective in helping their adoption of a competence-based approach during their ordinary activity.

To achieve the first goal, we are trying to involve some teachers in a new definition of some competences for computer science, in Italian secondary school of the technical field. The teachers participating to the experiment will use a software application, called CoMak (Competence Maker), which is a discussion forum customised for this specific interest. They will propose personal definitions of competence, then the specific community will discuss the proposal and, if the proposal will be accepted, the new competence definition will be add to the repository of the institutional competences.

The same competences repository is one of the main section of the database, on which has been build the software application we are using to pursue the second goal of the research. This application is named OPLA', from an Italian acronym meaning “*projects support for learning labs*”.

The OPLA' is currently used by a group of teachers of different schools, as a support for learning project which their pupils are going to develop. The same software, with similar purpose, is also used by computer science teachers who are attending an action-research on PBL, promoted as a part of our research. We chose to study the method of PBL, because it is an educational method which is suitable with the competence-based approach. In the first meeting of the course, we asked the teachers by a questionnaire to define a possible project for a class, trying to highlight the competences, specific for computer science, involved in its development. In the following steps we will observe the attendee, when they will design and then will conduct the project with the pupils. The software helps the teachers to perceive the development of their learning project as a set of activities which can be easily realised in the framework of the competence-based approach. Moreover, the software will allow to share the projects' materials; in this way, the teachers will be helped to exchange opinions and impressions, on their materials but also on the method and on the competence framework. At the end of the course we will try to summarise some important points of the PBL method. And we will propose the attendee the same questionnaire of the first lecture, trying to understand any changes, related to: the way they design the PBL; the way in which the project is suitable to the competence-based approach.

A presentation of any preliminary ideas, the proposed approach and achieved results

- In November 2014, we had the first survey on the popularity of the competence-based approach, among teachers of different subjects. At the beginning of this year we collected the second set of data, limiting the sample to a group of computer science teachers. Recently, we started the action-research course, even if with a small number of teachers. We collected the first results of a questionnaire, also comparing these results with the opinions of two researchers. The CoMak software, which will support the participated definition of the competences, has been designed and its developing phase is now on going.
- During the first survey, we organised some brainstorming groups with around 60 teachers of different disciplines, to gather the first set of data. Then, we contacted a group of computer science teachers, and we had eleven personal semi-structured interviews, recorded and analysed to extract some common points on the adoption of the competence approach at school, categorising the concepts obtained by the answers. The collected data require a qualitative analysis, which we also applied during the ongoing training course for computer science teachers, to the first results of a questionnaire. The questionnaire is mainly based on open questions. Specifically for the section related to the learning objectives of the learning project, the answers are expressed in the form of simple statements, assigned by the attendees to the knowledge or to the skills category, as main component of the competence. Then we anonymised the statements and hid the related category, asking two researchers to give the adequate category to the attendees' statements. Surprisingly, the categorisation of the teachers and of the experts are divergent. ***A sketch of the applied research methodology (data collection and analyzing methods)***
- The two different goals of the research require different kinds of evaluation, also related to different expected achievement. For the definition of the competences, we only expect a participation by the engaged teachers. We expect a process of comparing among teachers, useful to understand the meaning of specific competences, and the role that competence definitions may have in general for teaching purposes. The number of proposals, the number of opinions and the number of participants around every single proposal, the time a proposal will be under discussion, and the number of proposals accepted by the members will give a sign of the quality of the survey. For the second goal, i.e. the support to adopt the competence-based approach in the PBL, we expect different results to the second filling of the questionnaire. Particularly, we think that most teachers will suggest, for their PBL project, a better and clearer set of references to the competence-based approach than in the first filling. ***Expected achievements and possible evaluation metrics to establish the level of success of your results***

Bibliographic References

1. White, R.H. 1959. Motivation reconsidered: the concept of competence. *Psychological Review*, Vol. 66 (5), pp. 279-333
2. McClelland, D. C. 1973. Testing for competence rather than for 'intelligence.' *American Psychologist*, 28(1), 1-14. doi:10.1037/h0034092
3. Recommendation of the European Parliament and of the Council of 18 December 2006 on key competences for lifelong learning. Official Journal of the European Union 06.05.2008 (2008/C111/01) pp-10-18. Retrieved 4 November, 2014 on <http://eur-lex.europa.eu/LexUriServ/LexUriServ.do?uri=OJ:L:2006:394:0010:0018:en:PDF>
4. Hyland, T. 1997. Reconsidering competence. *Journal of Philosophy of Education*, Vol. 31 No. 3, pp. 491-503

Expectations and motivation to attend Doctoral School

I've really appreciated the spirit of research community I experienced last year, during my first participation at the doctoral school. I think we will live that spirit, again in this edition. As for me, the motivation is stronger because of my raised awareness of the importance of receiving feedbacks and collecting observations from researchers with different interests and points of view. I expect to meet researchers interested in the competence-based approach to education and in the project-based learning method, even with different attentions on the various aspects of the issues. I expect also to compare the study experiences on the field, involving different research aspects, in different countries, and by various points of view. Discussing on the measuring of different competence levels could be another challenging and common interest.

COMPUTATIONAL THINKING IN DUTCH SECONDARY EDUCATION

Grgurina Nataša

Teacher Education, Faculty of Behavioural and Social Sciences, University of Groningen
 P.O. Box 800, 9700 AV Groningen, The Netherlands
 n.grgurina@rug.nl

The paper attached in the summaries was published in the proceeding of ISSEP 2013 conference and it describes the research design as planned at that moment. In the meantime, phase 1 has been rounded up: the occurrence of Computational Thinking (CT) in existing teaching materials and additional literature have been explored and operational definition of CT focusing on Algorithms & Procedures, Data Collection and Modeling & Simulation was used to establish Pedagogical Content Knowledge (PCK) of a number of Computer Science (CS) teachers.

Currently, in phase 2, we are exploring the occurrences of CT in students' work in their assignments concerning Modeling & Simulations. To this end, we gathered data during the work of fourteen grade 12 students on a practical assignment: project documentation containing detailed description of all the system development steps, the resulting code, their reflections on the whole process, survey results, interviews with five students and screen recordings during their work. The preliminary results of this study were presented at the WiPSCE 2015 conference [1].

Right now, we are in the process of detailed analysis of all the gathered data, in particular the recordings. In addition to theoretical framework discussed in the WiPSCE paper, we are looking at the modeling competences describes by Maass [2]. The results of current work will be used to develop an instrument for the assessment of students' CT problem solving skills specifically focusing on Modeling & Simulation.

References

- [1] Grgurina, N., Barendsen, E., van Veen, K., Suhre, C. and Zwaneveld, B. Exploring Students' Computational Thinking Skills in Modeling and Simulation Projects: a Pilot Study. In *Proceedings of the Workshop in Primary and Secondary Computing Education*. ACM, 2015, 65-68.
- [2] Maaß, K. What are modelling competencies? *ZDM*, 38, 2 (2006), 113-142.

Abstract. We shall examine the Pedagogical Content Knowledge (PCK) of Computer Science (CS) teachers concerning students' Computational Thinking (CT) problem solving skills within the context of a CS course in Dutch secondary education and thus obtain an operational definition of CT and ascertain appropriate teaching methodology. Next we shall develop an instrument to assess students' CT and design a curriculum intervention geared toward teaching and improving students' CT problem solving skills and competences. As a result, this research will yield an operational definition of CT, knowledge about CT PCK, a CT assessment instrument and teaching materials and accompanying teacher instructions. It shall contribute to CS teacher education, development of CT education and to education in other (STEM) subjects where CT plays a supporting role, both nationally and internationally.

Keywords: computational thinking, situated learning, engaged computing, computer science

1. Present Situation

In 2006, J.M. Wing asserted that “to reading, writing, and arithmetic, we should add computational thinking to every child’s analytical ability” [6]. Educators recognize this need and inquire into the precise description of this concept and the ways to teach it. In 2010 in the United States, the National Research Council held a workshop on the nature and scope of Computational Thinking (CT). While there was a broad consensus on the importance of (teaching) CT, the workshop did not achieve a conclusive definition of this concept [4]. The Computational Thinking Task Force of CSTA did however suggest an operational definition of CT tailored to the needs of K-12 education. They state that:

CT is a problem-solving process that includes (but is not limited to) the following characteristics:

- *Formulating problems in a way that enables us to use a computer and other tools to help solve them*

- *Logically organizing and analyzing data*
- *Representing data through abstractions, such as models and simulations*
- *Automating solutions through algorithmic thinking (a series of ordered steps)*
- *Identifying, analyzing, and implementing possible solutions with the goal of achieving the most efficient and effective combination of steps and resources*
- *Generalizing and transferring this problem-solving process to a wide variety of problems*

These skills are supported and enhanced by a number of dispositions or attitudes that are essential dimensions of CT. These dispositions or attitudes include:

- *Confidence in dealing with complexity*
- *Persistence in working with difficult problems*
- *Tolerance for ambiguity*
- *The ability to deal with open-ended problems*
- *The ability to communicate and work with others to achieve a common goal or solution [2]*

In the USA and the UK, teaching these CT problem solving skills does not get enough attention from policy makers and is hardly represented in school curricula [5]. In the Netherlands, the situation is similar [1]. The Computer Science (CS) course in the upper grades of secondary education seems to be a natural setting to introduce CT teaching. In this course students regularly collaborate on large practical assignments based on realistic problems in order to produce working solutions. For example, a typical assignment would require students to design a model of traffic lights for a busy crossing or elevators for an apartment building. Both these problems:

- Are open and can have various correct solutions;
- Come with a minimal specification, prompting the students to investigate the behavior of the system to be modeled and thus encouraging them to use higher order thinking skills;
- Originate from the *real world*: solving (modeling) them necessitates the use of information-processing agents – like those used within a CS course.

2. Research

Obviously, a number of aspects of CT can be recognized in regular CS teaching practice, albeit lacking coherence and not being explicitly specified as learning objectives in the CS curriculum. Therefore, we propose to conduct design research concerning the teaching and learning of Computational Thinking (CT) within the context of a CS course in upper secondary education in the Netherlands. This research will take four to six years and will result in a PhD dissertation.

2.1. Research Questions

We shall study the following issues:

1. What is an operational definition of Computational Thinking, tailored to the specific situation and needs of secondary education in the Netherlands?
2. How can students' CT problem solving skills be assessed?
3. What is a suitable pedagogical approach to teaching students and stimulating their learning of CT problem solving skills?

2.2. Method

In this research, a curriculum intervention (pedagogical approach, teaching materials and teacher education materials) and an appropriate CT assessment tool will be developed as a result of an iterative (cyclic) process.

The first phase of the research is dedicated to obtaining an operational definition of CT. In the second phase, an instrument for the assessment of students' CT will be developed. The results of these two phases will yield the data for the pedagogical approach that will be developed in the third phase of the research: a curriculum intervention for students as well as accompanying teachers' instructions will be developed and tested in a pilot. In the fourth phase, the effects of the curriculum intervention will be assessed in an experiment on a larger scale and the final version of curriculum intervention (i.e. teaching materials) will be developed.

Phase 1.

Essential aspects of CT will be described, based on the CSTA definition of CT, existing teaching materials and additional literature. This draft definition will be presented to a number of experienced CS teachers. Their pedagogical content knowledge (PCK) pertaining to aspects of CT described in the draft definition will be established using content representation framework [3]. This will yield a final operational definition of CT tailored to the needs of CS course in Dutch secondary education.

Phase 2.

The CT description obtained in phase 1 will be used to develop an instrument for the assessment of students' CT problem solving skills. After consulting with experts, both nationally and internationally, and necessary modifications the author will test this instrument for usability and reliability in her own classroom while teaching CS using suitable sections of regular teaching materials. The findings will lead to final adjustments of this instrument. At the same time, the students' learning will be observed through video and sound recordings of individual and collaborative work, semi-structured interviews and other qualitative methods. Special attention will be paid to the difficulties students experience, misconceptions, use of CT skills and visibility of problem solving strategies.

Phase 3.

The findings of the phases 1 and 2 will contribute to the development of teaching materials for students and instructions for teachers (in the form of a course for teachers). The design of students' materials will be based on the idea of working with concrete problems in real world situations (situated learning). The curriculum intervention includes programming and modeling using freely available software.

After consultations with national and international experts (and possible modifications), these teaching materials will be tested by a small number of teachers who will report their experiences and findings through questionnaires and interviews. This will lead to further adjustments of the teaching materials.

Phase 4.

The experiment will take place in some dozen schools. Using the CT assessment instrument mentioned earlier, the effect of curriculum intervention (i.e. teaching with newly developed teaching materials and an associated pedagogical approach) on students' CT problem solving skills will be assessed and compared to CT problem solving skills of the students in control groups who were not taught CT problem solving skills explicitly. This will also lead to further adjustments of teaching materials.

3. Results

There has not been much research on (the effects of) teachers' instructions on CT problem solving skills of their students. This research will provide an assessment tool to make students' learning of CT visible, together with a validated assessment instrument to measure students' computational thinking. Furthermore, teaching materials for students and accompanying teachers' instructions will be developed.

Since CT can be viewed as a form of situated learning, the results of this research will be interesting for scientific research into situated learning in related STEM subjects.

New insights into teaching and learning CT will help teachers to prepare their students more adequately for life in our modern society and for effectively applying CT professionally, regardless of whether ICT plays a central role in their occupation or not. Teacher training departments will be equipped better to prepare future (CS) teachers for their jobs.

Besides the contribution of this research to the growth of the body of CS pedagogical content knowledge in general, it will mean to the author a further development of the pedagogical approach she has been practicing in her classes for years and which has convinced her more and more that that CS is not an isolated art but one that facilitates learning and understanding in other disciplines.

References

1. Barendsen, E., & Zwaneveld, B. (2010). Informatica in het voortgezet onderwijs - voorstel voor vakvernieuwing (Notitie voor KNAW).
2. CSTA, <http://csta.acm.org/Curriculum/sub/CompThinking.html>, retrieved February 2012.
3. Loughran, J., Berry, A., & Mulhall, P. (2006). Understanding and developing science teachers' pedagogical content knowledge.
4. National Research Council (US). Committee for the Workshops on Computational Thinking. (2010). Report of a workshop on the scope and nature of computational thinking, Natl Academy Pr.
5. Schnabel, R. B. (2011). Educating computing's next generation. *Communications of the ACM*, 54(4), 5-5.
6. Wing, J. M. (2006). Computational thinking. *Communications of the ACM*, 49(3), 33-35.

DATA MANAGEMENT IN SECONDARY COMPUTING EDUCATION

Grillenberger Andreas

PhD student since November 2013

Friedrich-Alexander-Universität Erlangen-Nürnberg Computing Education Research Group

Martensstraße 3

91058 Erlangen, Germany

andreas.grillenberger@fau.de

Biography

I have completed my studies for becoming a computer science and physics teacher at German upper secondary schools at the University of Erlangen-Nuremberg in March 2013. My thesis was focused on a new tool for supporting teaching of the topic databases in secondary computing education and was presented at the *7th Workshop in Primary and Secondary Computing Education* in Hamburg (Grillenberger & Brinda, 2012).

After these studies, I decided to further work on a related topic as my PhD topic: since November 2013, I am research assistant in the computing education research group at the University of Erlangen-Nuremberg. My PhD advisor is Prof. Dr. Ralf Romeike, with whom I am working on bringing the innovations in data management to secondary computing education.

Research area description

Topics like Big Data, NoSQL, data analysis and so on are dominating in CS research and practice in the last years. Additionally, for example in news and media, people encounter various data management terms in their daily lives and need various competencies for handling all the data they generate continuously. In contrast, current (secondary) computing education mainly emphasizes the storage of well-structured data in mainly relational databases while important aspects like Data Privacy or Data Security are only mentioned marginally. In my work, I am trying to find the central and fundamental ideas and concepts of this large field in order to bring these aspects to computing education.

Preliminary work

We first started with analyzing the scientific developments in data management and, based on these, the important challenges that are arising for CS education in this context (Grillenberger & Romeike, 2014b): e.g. involving (real) Big Data examples into teaching, showing up the principles of data mining, and sharpening the view on data privacy.

In parallel to this work, we also emphasized the relevance of the concepts and ideas behind data management for everyone's daily life: people often have to deal with phenomena that are arising from the use of data management methods and concepts. For example, while in school redundancy is often avoided for ensuring consistency, in other contexts people (should) often use redundancy for purpose, e.g. when creating data backups. But also when discussing about data synchronization, redundancy and consistency are concepts that are important to understand, e.g. in relation to statements like "I don't need an extra data backup – I synchronize all my data to Dropbox". However, schools are typically only considering the one side of the coin. This is exactly the same for several other topics, so that acquiring key competencies in these fields can strongly support dealing with modern data management topics in the everyday life (Grillenberger & Romeike, 2014a).

As the relevance of these innovations in data management in current CS education was not investigated yet, an important basis for our work was identifying the gap between data management in computer science and its representation in computing education. Therefore, we analyzed several educational standards and curricula from several countries on the aspects of data management that are covered (Grillenberger & Romeike, 2014c). The results of this study confirmed our presumptions: current database education mainly concentrates on storing data in mainly relational databases and on using SQL. Aspects like data security and privacy as well as the social, legal and ethical implications are only considered marginally. Also, data analysis, backup and recovery, cloud storage, distributed data

storage and so on are hardly mentioned at all. Only one of the 12 analyzed documents covers the topic meta-data. In contrast, this topic is an important aspect of current discussions on surveillance by intelligence agencies and public discourse in general, but people often do not realize that they are also affected by the impacts of data management. As we compared this representation of topics in current CS education to a characterization of data management from a professional view (DAMA, 2009), we found that there is a clear gap between current teaching and the research in this field. While the professional characterization of data management also covers all the aspects of current CS education in this field, most of the aspects of data management are not part of current teaching so far. An overview of the results of this study is shown in diagram 1.

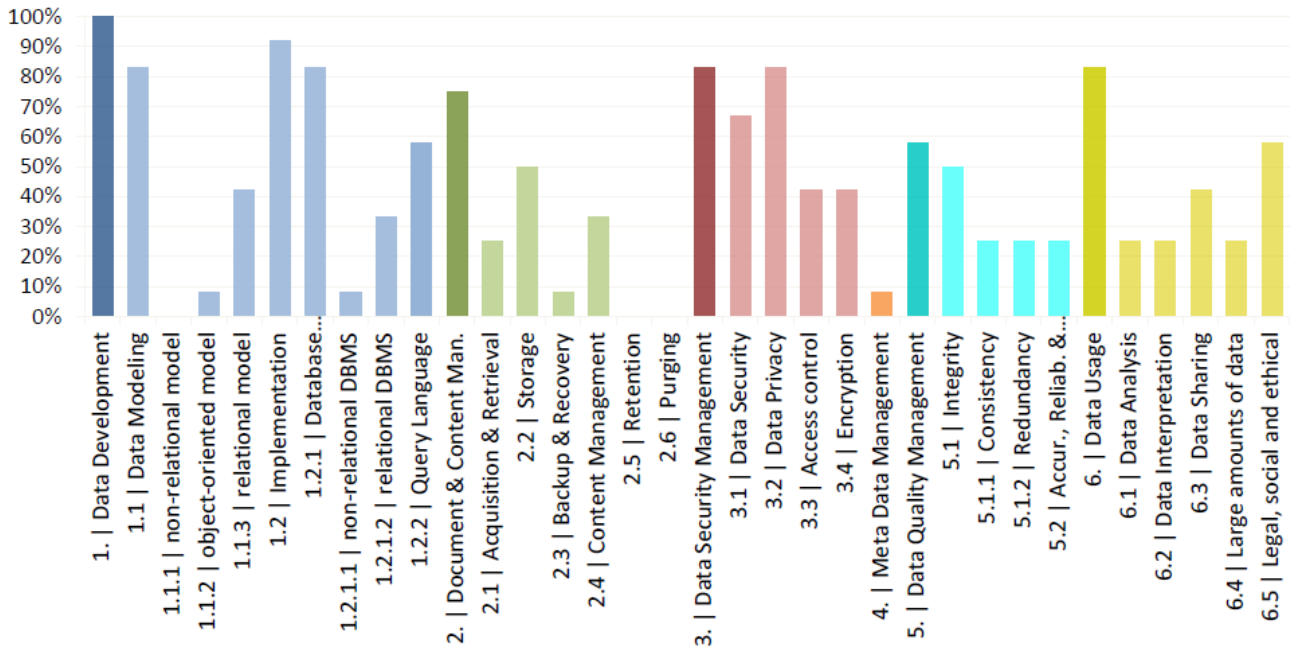

Diagram 1: Results of our study on the representation of Data Management in current secondary CS education. The darker bars represent the top-level categories which were coded always when one of its subcategories (same color) was coded.

While with this work we have shown the relevance of the modern data management topics for everyone as well as its missing representation in schools, we cannot directly decide on whether bringing such topics to school is rational or not: not every aspect of CS can be reduced in complexity so that it shows the central ideas and concepts from a CS point-of-view in a way that is suitable for students. Also, focusing on the long-lasting principles instead of short-living innovations and the focus on aspects that are strongly connected to the students life are important principles in general CS education. Such criteria were for example defined by Schwill in his work on the fundamental ideas of computer science (Schwill, 1994) and hence are an important basis for our work.

Research Questions & Goals

The shortage of modern data management topics in CS education shows that this topic is only considered marginally at the moment. In order to meet the current relevance of this topic in CS research and practice, the question guiding my research is:

Which are the influences of current developments in data management on secondary computing education and how can CS education handle the newly arising requirements in this field?

Answering this question not only includes a broader view on the topic *data* in current CS education, but also answering the following sub-questions:

1. How is everyone affected by data management in his/her daily life?
2. Which are the fundamental and long-lasting aspects of data management that are important for computing education?
2. What knowledge and skills does everyone need to have concerning data management?

3. Which pre-knowledge, attitudes and perceptions do learners currently have on this topic as well as on the chances and threats of data management?

Research Framework

For answering these questions, an appropriate framework is educational reconstruction as presented by Diethelm et al. (2012). According to this framework, creating a course design is based on five pillars (cf. fig. 1), that I will shortly summarize in the following. A more detailed description of how we plan to apply this framework on data management can also be found in our publication at this years' WiPSCE (Grillenberger & Romeike, 2015c).

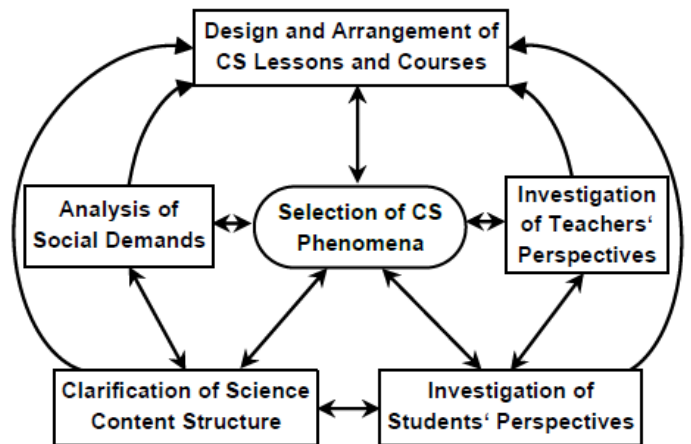

Figure 1: Model of educational reconstruction, adapted for Computer Science Education (Diethelm et. al.,2012)

Selection of CS Phenomena

While the starting point of the innovations in CS is in the science, the area in which students may be confronted with such developments is their own daily life: Computer science especially becomes visible to everyone by the phenomena that occur in everyday life. So, such phenomena can act as great starting points for CS education, as they pick up questions or statements with which the students may have been confronted before. Some short example for such statements that can lead us to CS phenomena in this field is depicted in fig. 2. Hence, the main questions in this step of educational reconstruction are:

- Which phenomena can act as starting points for CS education?
- How can data management contribute to the explanation aspects of the students' everyday lives?
- Is data management able to support tasks and activities of the daily life—even beyond such that are strongly related to CS?

Analysis of Social Demands

As school teaching is influenced by various external influences, e.g. legal and curricular requirements, educational standards, requirements of the society to a certain subject as well as the educational system (Grillenberger & Romeike, 2015c), taking into account these demands is also an important aspect of educational reconstruction. With the rising impact of data management in modern topics like cyber-physical systems, smart phones, smart homes, smart cars, smart factories, and so on, the demands on CS teaching in this field will also increase. In this context, important questions to answer are:

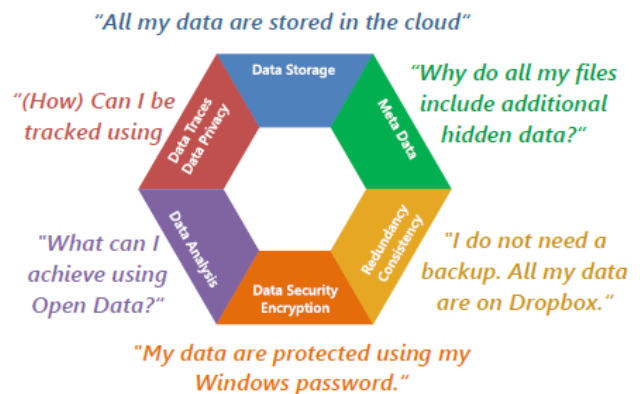

Figure 2: Statements on the use of data that can lead to different CS phenomena

- With which demands from society and daily life is general CS education confronted today?
- Which relevance does the science content have in this context?
- What does everyone need to know about data management?

Clarification of the Science Content Structure

This phase considers the scientific point-of-view in the topic. As the innovations in data management are coming from the scientific development, considering this development and the way the topic is structured from a scientific point-of-view is important for finding the new topics, ideas, concepts and methods behind it. So, central questions in this phase are:

- Which are the central terms, ideas, concepts and methods of a topic?
- How is the topic structured from a scientific point of view?
- Which of the central ideas in this field are part of CS education yet and where is a gap between the science content and current CS education?
- How do the potential topics fit into current CS education?

Consideration of the Students' and Teachers' Perspectives

Considering the perspectives of both types of actor in teaching, the students and the teachers, is also an important task. For both groups, this is mainly done by considering knowledge aspects and by considering how to support the learning process. So, main questions in this field are:

- Which perceptions do students have on the central concepts of data management?
- Which ideas are useful and practicable for students?
- What pre-knowledge do students need for understanding data management concepts and ideas?
- Which knowledge do teachers need about data management?
- How can developing pedagogical content knowledge (PCK) on data management be fostered?
- At which points can teachers be supported, e. g. by developing tools or by selecting suitable materials and examples?

First iteration: doing real-time data analysis with secondary students

In a first iteration, I applied the described research framework on one of the topics of data management, the so-called data stream systems. Such systems comprise many interesting ideas and concepts, that can be found in other parts of CS as well: monitoring, filtering, aggregation, parallelization and so on. Yet, we were often confronted with the question if we really think we can do such complex topics like data stream analysis with secondary students, as these systems are highly complex and have hard-to-understand underlying principles (especially such coming from statistics). Hence, after doing an analysis of the scientific point-of-view on this topic and its underlying ideas, we found it acceptable to abstract from e.g. the statistical principles and concentrate on the data processing aspects of these systems. As starting point for teaching this topic, we selected the occurrence of real-time data analysis in our daily life: e.g. the Twitter start page manages to provide trends by analyzing all tweets in real-time, even if this are about 6,000 per second—but how is this possible? But doing such analysis with students at school is not possible without an appropriate tool – which did not exist, as typical data stream systems are not usable without deep knowledge. So, what we did for meeting the students but also the teachers demands here, is developing a fairly easy-to-use tool based on the programming environment Snap! (Grillenberger & Romeike, 2015b). With this tool, students can carry out own data analysis on a well-known data source – the Twitter data stream – without any pre-knowledge on either data stream systems or on how to connect to this data source. We also described some key points on a lesson design which was also discussed with teachers as first evaluation (only available in German: Grillenberger & Romeike, 2015a)

Future Work / Expected Contributions

In my future work, I plan to apply the described framework on the complete field data management. Some first steps of this have already been done, but there is much work left to do. By doing this, key points for teaching data management in school will be developed, that we expect to strongly differ from what is currently being done at school in the field databases. So, this work prepares including the fundamental and long-lasting aspects of this topic into further CS education curricula. Thereby, we also

aim on providing students a better understanding of current developments and on enabling them to handle their data in daily life in a proper and responsible way.

Bibliographic References

- DAMA International (2009): *The DAMA Guide to the Data Management Body of Knowledge (DAMA-DMBOK)*. Technics Publications, LLC.
- Diethelm, Ira and Hubwieser, Peter and Klaus, Robert (2012): *Students, teachers and phenomena: educational reconstruction for computer science education*. In: Laakso, Mikko-Jussi and McCartney, Robert (Eds.): Proceedings of the 12th Koli Calling International Conference on Computing Education Research.
- Grillenberger, Andreas and Brinda, Torsten (2012): *eledSQL: a new web-based learning environment for teaching databases and SQL at secondary school level*. In: Knobelsdorf, Maria and Romeike, Ralf (Eds.): Grand Challenges in Primary and Secondary Computing Education.
- Grillenberger, Andreas and Romeike, Ralf (2014a): *Teaching Data Management: Key Competencies and Opportunities*. In: Brinda, Torsten and Reynolds, Nicholas and Romeike, Ralf (Eds.): KEYCIT 2014.
- Grillenberger, Andreas and Romeike, Ralf (2014b): *Big Data – Challenges for Computer Science Education*. In: Gülbahar, Yasemin and Karatas, Erinç (Eds.): Informatics in Schools. Teaching and Learning Perspectives.
- Grillenberger, Andreas and Romeike, Ralf (2014c): *A Comparison of the Field Data Management and its Representation in Secondary CS Curricula*. In: Caspersen, Michael and Gal-Ezer, Judith and Schulte, Carsten (Eds.): WiPSCE 2014.
- Grillenberger, Andreas and Romeike, Ralf (2015a): *Big-Data-Analyse im Informatikunterricht mit Datenstromsystemen: ein Unterrichtsbeispiel*. In: Gallenbacher, Jens (Ed.): INFOS 2015: Informatik allgemeinbildend begreifen.
- Grillenberger, Andreas and Romeike, Ralf (2015b): *Analyzing the Twitter Data Stream Using the Snap! Learning Environment*. In: Brodnik, Andrej and Vahrenhold, Jan (Eds.): ISSEP 2015.
- Grillenberger, Andreas and Romeike, Ralf (2015c): *Bringing the Innovations in Data Management to CS Education: an Educational Reconstruction Approach*. In: Gal-Ezer, Judith and Sentence, Sue and Vahrenhold, Jan (Eds.): WiPSCE'15.

Expectations and motivation to attend Doctoral Consortium

As I was participating in last years' doctoral consortium, I really appreciated the good and fruitful working atmosphere but especially also the input by experienced researchers. By discussing my work for all these days and by gaining insight into what others are currently working on, I expect some important tips and ideas that can bring forward my work. Also, getting into contact with other people from the computing education research community is an important reason why I want to attend this doctoral consortium.

E-LEARNING OBJECTS DESIGN MODEL BASED ON SEMANTIC WEB TECHNOLOGIES

Gudoniene Daina

2nd year studies
Institute of Mathematics and Informatics at Vilnius University
Akademijos str. 4
Vilnius, LT-08663, LITHUANIA
daina.gudoniene@gmail.com

Your Brief Biography

During first year of studies the research was presented at 4 conferences:

1. *Information and Communication Theories and Practices. 2015. National Scientific Conference.* March 17th., Vilnius, Lithuania.
2. *e-Learning'15: International Conference*, September 11 th., Berlyn, Germany.
3. *Computer's days 2015. National conference.* September 18 th., Panevezys, Lithuania.
4. *In ICIST'2015: International Conference*, October 16 th., Druskininkai, Lithuania.

The research presented in the scientific international journals during the first year of studies:

1. Dagienė V., Gudonienė D. (2015) The Innovative Methods for Massive Open Online Courses Design. *Baltic Journal of Modern Computing*, Vol. 3 (2015), No. 3, P. 205-213.
2. Dagienė V., Gudoniene D., Burbaitė, R. (2015) Semantic Web Technologies for e-Learning: Models and Implementation. *Informatica*, (2015), Vol. 26, No. 2, P. 221-240.
3. Gudonienė D., Rutkauskienė, D. (2015) The first MOOCs in Lithuania: Learning Objects role for Learning Quality. *Informacijos mokslai*, (2015)71, P. 115-123.

Research area description

The research presents a problem of using semantic terms and the need for the use of semantic technologies in the development of training facilities by using learning objects. The teacher's community express a need to have their own concepts in the field, as one of the essential elements in the field of education. The question is how to improve and enrich the training courses by using semantic learning objects (SLO).

The aim of research is to explore the ways, problems and perspectives of learning objects design and to develop a semantic technology-based learning model for learning program improvement.

One of the objectives in the research is to create a model for e-learning based on semantic web technologies and link it to the architecture of the educational system, as well as to present an experimental part of the model's impact on the course design process.

The research presents: (1) the semantic web technology in education, usability, existing international practice to perform modern training facilities overview; (2) the exploration of existing LOs design approaches and models; (3) a model for semantic LOs design, architecture of semantic learning object design; (4) results of the experiment on the model's impact on the course design process.

Nowadays the web can serve as a perfect technological environment for personalized learning, which is suggested by educators and based on interactive learning objects. While a range of technological solutions for the development of integrated e-learning environments already exists, the most appropriate solutions require further improvement on implementation of novel learning objects, unification of standardization and integration of learning environments based on semantic web services that are still in the early stages of development. The aim of the research is to create a framework for the development of semantic learning objects, connect it with the architecture of the educational system for semantic learning object design and present an experimental part of the model's impact on the course design process. The research is based on the main question on how to improve e-learning course with semantic learning objects by exploring the application of learning object design approaches,

usability, performing modern training facilities and the learning object design model based on semantic web technologies.

A presentation of any preliminary ideas, the proposed approach and achieved results

A systematic review of the related research works and analytical research methods were used for revealing the advantages of the use of semantic web technologies in e-learning (phase 2) and for raising issues related to the semantic learning objects use in semantic education (phase 1) as well as for exploring existing LOs design approaches and models (phase 2) and for extracting initial data from our model linked to a theoretical framework (phase 3). Descriptive research used: (1) to explain created the model and architecture of the educational system for semantic learning object design belongs to problem solution (phase 3); (2) to evaluate the theoretical relevance (phase 6); (3) to present the results of the experiment (phase 4). Case study method involves the experiment on the model's impact on course design process (phase 4).

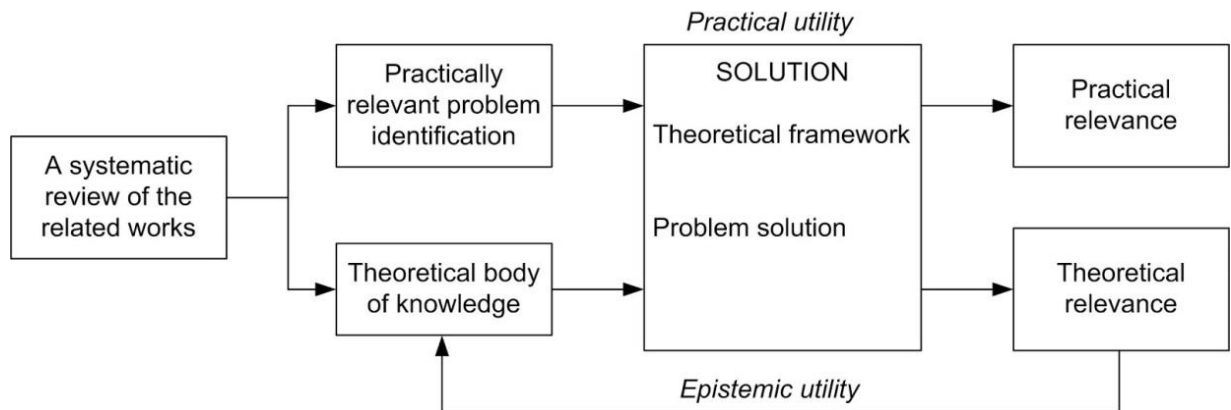

Figure 1. Constructive research approach diagram

The presented research related with computers course design for eventual use with 94 respondents in higher education institutions in Lithuania. The researchers developed a test to evaluate the effectiveness of the course developed by using e-learning object design model based on semantic web technologies. There was organized a test and pilots it in a different higher education institutions, administrating the test to 94 respondents to evaluate the impact on the course design process.

During the research, an important of LOs composed of content elements with semantic relations, automatic generation before it describes the content elements with semantic relations identified. There presented a framework for the development of semantic LOs as a sequence of semantic learning objects pre-design, design and post-design processes (fig. 2).

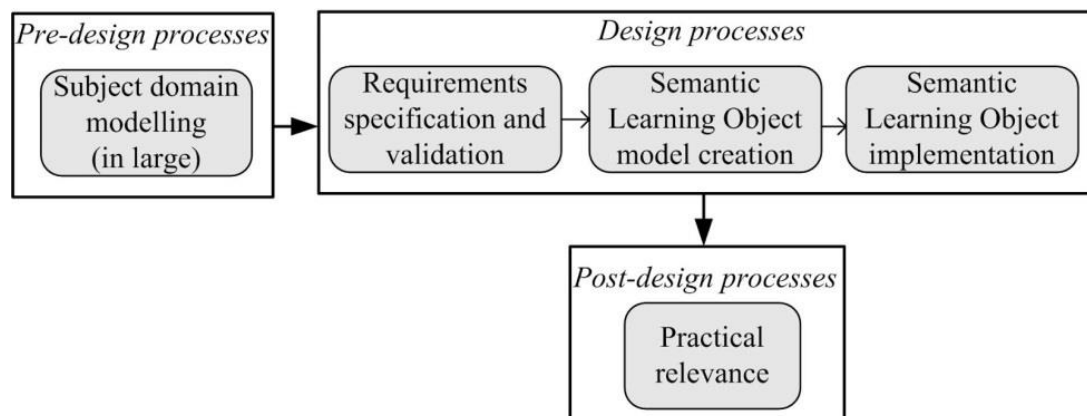

Figure 2 A framework for the development of semantic learning objects

Semantic learning objects pre-design process and design-based research is LOs based research paradigm holding the promise of introducing more teachers and trainers to work on improving content with semantic learning objects for educational purposes. However, there is a lack of methodological standards and established research processes. Although there are general principles and procedures

of LOs design model research when creating technology-based innovative learning environments. In this article describes a case study of learning object design based on semantic web technologies with the main interest of teachers and trainers to get the guidance for e-learning courses improvement of semantic technologies. In this case there has developed Semantic learning objects design educational system architecture framework (to find out the individual conceptual model, ontology or workflow and tutorial path for teachers and trainers).

Expectations and motivation to attend Doctoral Consortium

I have a great experience of the preview year and hope again to have a nice co-operation with the professional in my research area.

VIRTUAL LABORATORIES IN COMPUTER SCIENCE EDUCATION

Janiga Rober, Gunčaga Ján

Faculty of Education, Catholic University in Ružomberok, Slovakia

Significant development of information and communication technologies and especially the internet boom bring new possibilities in education of different school subjects at all levels of the educational process.

Information technology has provided new innovations to sustain constructing an artificial educational environment by means of computers. Certain artificial environments sometimes go beyond natural environments, such as simulations and virtual reality, which is a sophisticated educational technology.

A computer simulation which enables essential functions of laboratory experiments to be carried out on a computer is called a virtual laboratory. This simulation support aspect of visualization in educational process in different school subjects and it is possible to use it in educational process in different study programs of teacher training at universities.

Understanding of new notions through visualization belongs to important factors in the constructivist educational approach. We would like for this reason to present some aspects of visualization also through selected kinds of virtual labs.

Laboratory distance education opens new challenges such as separation of imperfections in technology and teaching methodologies and development of assessment strategies that provide reliable feedback about student learning capabilities. Feedback from students and experts provided a lot of constructive comments and suggestions.

Research problem

- ▶ Is it possible to create a system that enables individual education of fiberoptics using ICT, so that we can improve the level of adopting chosen competences (especially those, that students know the worst)?
 - ▶ Will the use of the virtual laboratory affects informatics competencies of students?
- Aim of the dissertation
- ▶ Create virtual labs to support educational process of fiberoptics subject.
 - ▶ Create list of methods and procedures that will be tested on student samples. We will verify, whether the required competences improved or not.
 - ▶ Determine the effectiveness of the development and understanding of the roles using the virtual laboratory through pedagogical experiment
 - ▶ Apply the latest trends and uses of virtual laboratories in information education with a view to promoting the development of key competencies, in particular digital ones.
- Partial aims of the dissertation
- ▶ Analyze scientific-methodological and pedagogical actuality of the problem in connection with the new objectives of the national curricula for ISCED science curriculum in high school
 - ▶ Analyze the issue of creating of electronic supporting materials in chosen development environments
 - ▶ Determine the effectiveness of the elaborating and understanding of the experiments using the virtual laboratory through pedagogical experiment

Apply the latest trends and uses of virtual laboratories in computer education with a view to promoting the development of key competencies, in particular the digital.

Reason for selecting the topic

Students through virtual laboratories can:

- generate ideas of physical phenomena,
- animate borderline cases of experiments that can not try in real lab,

- proceed at their own pace,
- learn independent research work,
- develop imagination,
- return to the experiment individually at home, as the software is freely available,
- better prepare to tackle demanding tasks

Process

- ▶ Requirements analysis and design of virtual laboratory
- ▶ Research sample (inclusion of students using pretest)
- ▶ Adjusting the virtual laboratory
- ▶ Testing, data collection and evaluation
- ▶ Analysis of the number of tasks elaborated / understood

Current state of the problem

- ▶ Currently is the social demand to develop technical and computer competences (PISA, OECD, EU core competencies).

We are going to try these specific laboratories in our research. (fig. 1 - 5)

- ▶ Wavelengths division multiplexing
- ▶ Digital and Analog link
- ▶ Bi.directional communication system
- ▶ Bending losses on optical fiber
- ▶ LED and Detectors characteristics

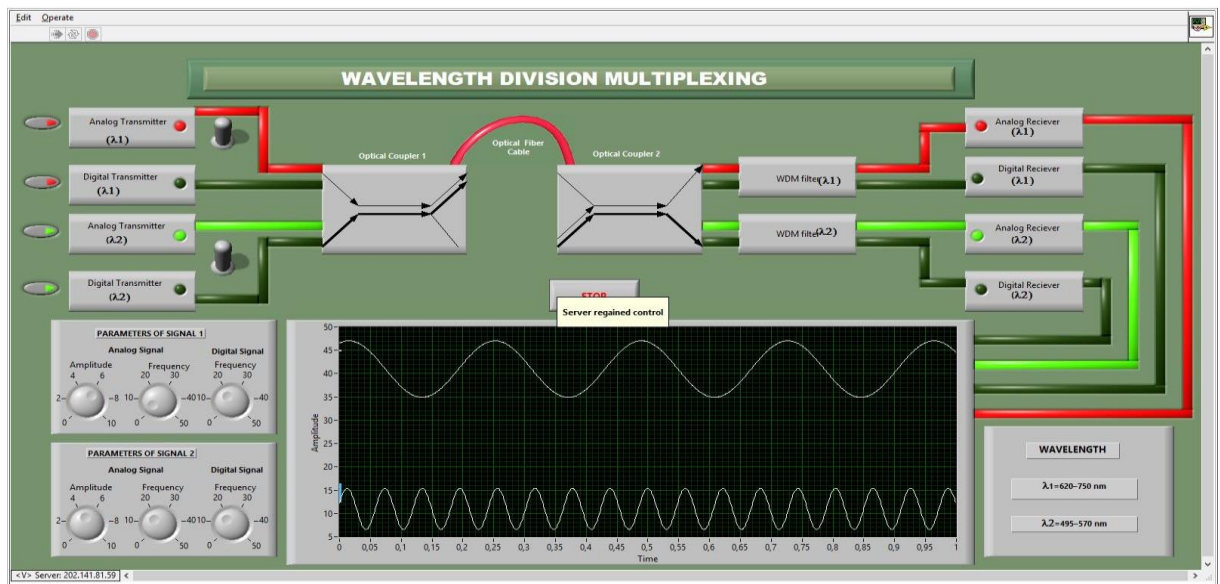

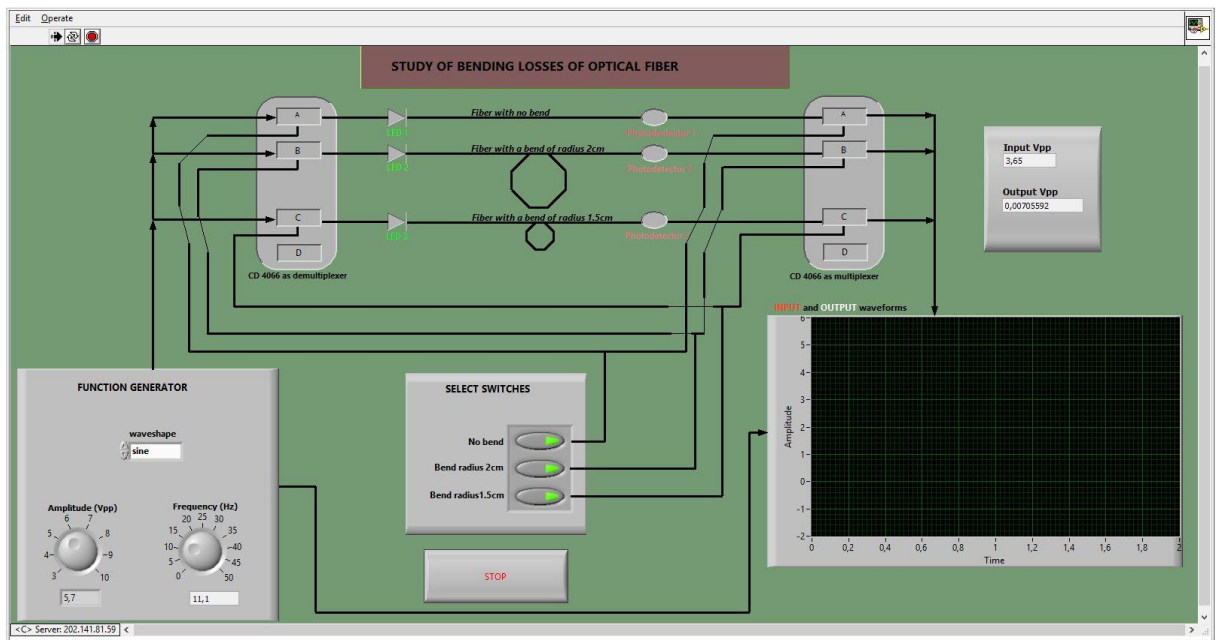
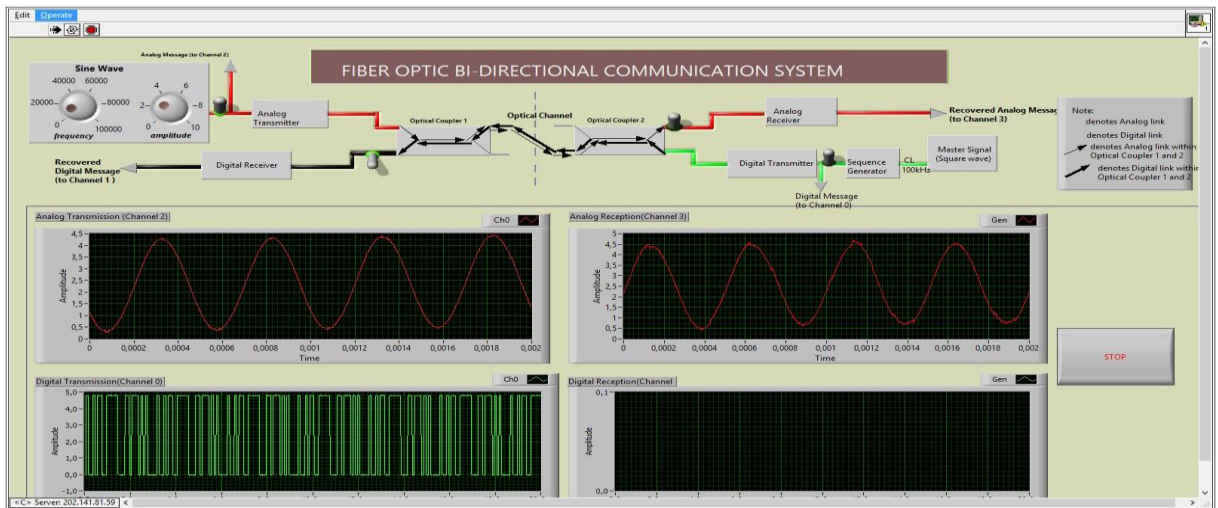
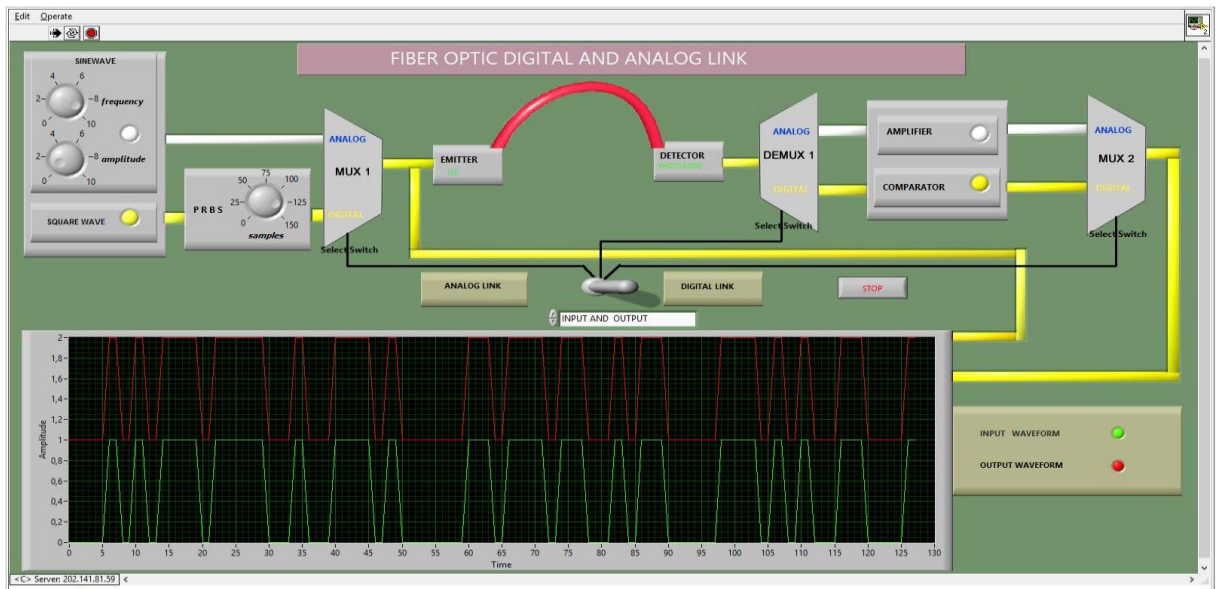

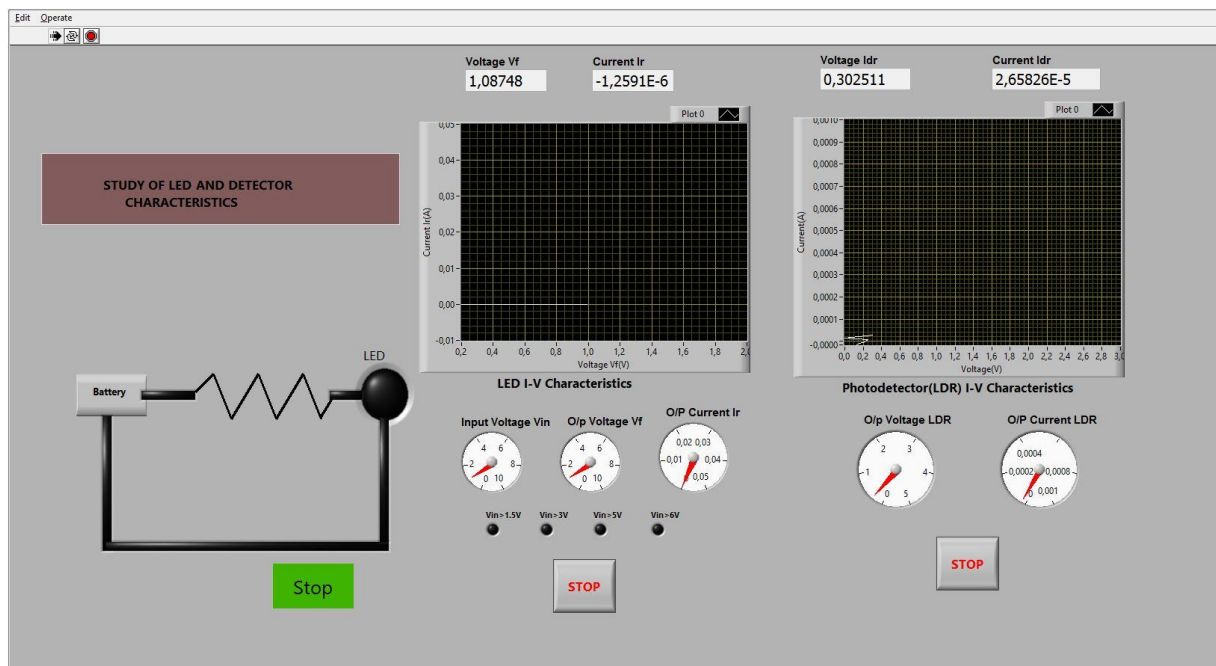

Proposal of pedagogical experiment

- ▶ Students will be divided into groups according to their abilities that will be tested before starting the actual teaching through virtual lab.
- ▶ After finishing the test semester of the subject will statistical evaluation of established hypotheses take place.
- ▶ In pedagogical experiment we observe the prediction, but also understanding of laboratory tasks.

Robert Janiga

Year of your doctoral studies: 2

Assistant at the Department of Informatics, Catholic University in Ruzomberok, Slovakia
Hrabovska cesta1/A,
Ruzomberok, 03406, Slovakia
robert.janiga@ku.sk

Brief Biography

Address:

Slnecná 8687/23, 03406 Ružomberok
+421905301600

2014 – now -Assistant at the Department of Informatics, Faculty of Education
Catholic University in Ruzomberok, Hrabovská cesta 1, 03401 Ružomberok

2008 – 2014 -Computer Technician at the Department of Informatics Catholic University in
Ruzomberok, PF, Hrabovská cesta 1, 03401 Ružomberok

2010 - PaedDr. – Rigorous exam – informatics - Catholic University in Ruzomberok

2007 -Mgr. – Teaching of subjects: English language and literature, Informatics
Catholic University in Ruzomberok

Publications and projects

GUNČAGA, J., JANIGA, R., Web 2.0 tools in education at PF CU in Ružomberok, In: MATHPHYS-BRIDGE and the conference Matematika és Informatika Didaktikai Kutatások-Researchers in Mathematics and Informatics Education (ICTLM-MIDK 2015), Novi Sad, Serbia.

- GUNČAGA, J., JANIGA, R., KRIŠŠ, Š.: EXPERIENCE OF USING MOODLE E-LEARNING ENVIRONMENT AT THE FACULTY OF EDUCATION. In: Information and Communication Technologies in Education 2014, Rožnov pod Radhoštěm, (Projekt č. 11420137).
- GUNČAGA, J., R. JANIGA and J. MAJHEROVÁ. Using Web 2.0 tools in education. In: KAPOUNOVÁ, J. (ed.) Information and Communication Technologies in Education Overview in Visegrad countries. Ostrava: Ostravská univerzita, 2014, pp. 33-40. ISBN 978-80-7464-701-7.
- JANIGA, R., ROJČEK, M. Vývoj CBT/WBT pre potreby typového školenia pilotov lietadla L-410 /In: Aplikace simulátorů ve výcviku leteckých specialistů [elektronický zdroj] : mezinárodní konference 18. - 19. 9. 2015, Ostrava - Mošnov / eds. Rudolf Volner, Aleš Stuchlík, Michaela Sedliaková. - [1. vyd.]. - Ostrava - Mošnov : LET'S FLY, 2015. - ISBN 978-80-260-8337-5. - CD-ROM, s. 178-187.
- JANIGA, R., ROJČEK, M., ČERNÁK, I., Zhukovanie kontextovo podobných dokumentov, pomocou algoritmu fuzzy c-means /In: Aplikace simulátorů ve výcviku leteckých specialistů [elektronický zdroj] : mezinárodní konference 18. - 19. 9. 2015, Ostrava - Mošnov / eds. Rudolf Volner, Aleš Stuchlík, Michaela Sedliaková. - [1. vyd.]. - Ostrava - Mošnov : LET'S FLY, 2015. - ISBN 978-80-260-8337-5. - CD-ROM, s. 188-201.
- GWOZDZ-LUKAWSKA, G., JANIGA, R., GUNČAGA, J. Supporting of simulation and visualisation in e- learning courses for STEM education. In: The Fourth International Conference on e- Technologies and Networks for Development (ICeND2015). - 1st ed. – Łódź : University of Technology, 2015. - ISBN 978-1-4799.8450-3, CD-ROM, pp. 66-71.
- GUNČAGA, J., JANIGA, R. Possibilities of using virtual laboratories in teaching computer science subjects In: ISIS Summit Vienna 2015: As we may teach ICT in education.
- VOLNER, R., JANIGA, R.: Projektovanie špeciálnych informačných systémov., Ružomberok: VERBUM, 2015. ISBN 978-80-561-0206-0.
- KEGA 002UJS-4/2014 Interactive electronic learning materials to support implementation of modern technology in teaching mathematics and informatics.
- GAPF 5/10/2014 (Grantová agentura Pedagogickej fakulty KU v Ružomberku) Študentská vedecká činnosť v didaktike informatiky 2015 vedúci riešiteľ: Ing. Janka Majherová, PhD.
- TACR, Program alfa, TA04031376 Výzkum/vývoj metodiky výcviku leteckých specialistů L410 UVP - E20 (2014-2017, TA0/TA).

Concept to experiment mapping: the concepts will need to be mapped to an experiment in such a way that they will teach students in an effective way while being sufficient without troubleshooting skill development over the system demonstration. The remote laboratories will lack the troubleshooting practices unless there is a mechanism to physically control the setup by moving components around and connecting them via a robot hand.

Parsing of experiment to simulation and remote data acquisition: the parsing has a great impact in the understanding of educational delivery methods in remote laboratories: e.g. perfect results of a fundamental concept through a simulation model might create confusion when the student is presented with the real-life experience from the actual laboratory results (including noise, system imperfections, etc.). The simulation should be able to address the imperfections in real-life cases to keep these confusions at a minimum.

The assessment plan will encompass both formative and summative assessment methods

Student Opinion Surveys will encompass questions related to the teaching methods in a remote setting. There are two questions that directly address the student knowledge acquisition. In addition, the demographics of access methods will be also collected.

In order to identify the teaching shortcomings and to separate these from the technological shortfalls, a hands-on test experiment in the lab will be conducted. The opinion survey from the hands-on experience will represent the fundamental differences between the remote and hands-on labs.

Questionare

- Were you able to conduct the experiment by yourself?
- Did you check the settings of the measuring equipment?
- Can you identify various different connectors used?

Did the virtual laboratory helped you understand the concepts better?
Were you able to set up the OSA correctly to get the spectrum characteristics.
Were you able to set up different wavelength ranges in the OSA.
Did the virtual laboratory give a similar experience to a real experiment.

Opinion survey

The control speed and bandwidth was big enough to do the lab
The remote control panel software was easy to use.
The instrument control was clear.
Instrument visualization was clear.
The laboratory helps in teaching the fiber link loss concepts.
The laboratory helps in teaching connector loss in fiber links.
Power readings for each of the link were easy to observe.
The remote laboratory provided a similar experience to a "hands-on" lab
The lab manual was easy to understand
The laboratory instructions were clear.
The web interface was easy to follow and understand.
The pre-lab was helpful in understanding and performing this lab.

Bibliographic References

- LUSTIG, F.: Integrace reálných, vzdálených a virtuálních laboratoří. In: Sborník konference Veletrh nápadů učitelů fyziky 12. Ed.: Dvořák, L. Prometheus, Praha, s. 155-159, 2007.
- AUER, M. E.: Virtual Lab versus Remote Lab. In: Proceedings of the 20th World Conference on Open Learning and Distance Education. Düsseldorf/Germany, April 1-5, 2001.
- NEDIC, Z., MACHOTKA, J., NAFALSKI, A.: Remote Laboratories versus Virtual and real Laboratories. In: Proceedings of the 33rd ASEE/IEEE Frontiers in Education Conference. Session T3E. Boulder/CO/USA, November 5-8, 2003.
- JAMES, P., VARY, E.: Report of the Expert Meeting on Virtual Laboratories. Technical Report CII-00/WS/01, International Institute of Theoretical and Applied Physics (IITAP), UNESCO 2000.
- FRANZL, R., GURKAN, D., BENHADDOU, D.: E-Learning Laboratories for Optical Circuits, Electrical and Computer Engineering , University of Colorado at Boulder

Expectations and motivation to attend Doctoral Consortium

We would like to attend the Doctoral Consortium to gain new experiences, present our research and discuss the methodology we can use in our research. We would like to ask for help in research methods-questionnaire, qualitative and quantitative research methods. We would like to ask for help in research methods- questionnaire, qualitative and quantitative research methods. Suitable tool and software for educational research such C.H.I.C, SPSS, EVASYS system and so on. How to choose research sample -students and teachers for experiment? How many respondents do we need for questionnaire research? If we would like to organize research experiment in secondary schools, how to cooperate with these schools? What experience do you have in cooperation with secondary schools in research for some dissertation? How to evaluate and how to interpret results of research for educational practise?

FREE SOFTWARE STRATEGIES OF MANAGING INFORMATION AND COMMUNICATION TECHNOLOGY INFRASTRUCTURE IN ESTONIA

Supervisor: Kaido Kikkas, PhD

Laugasson Edmund

Year of your doctoral studies: 4th

Digital Safety Lab, School of Digital Technologies, Tallinn University, Narva Road 25, 10120 Tallinn, Estonia

edmund.laugasson@gmail.com (in university: edmund@tlu.ee which is redirected to GMail)

GSM: +372 52 80 479

<http://www.tlu.ee/en/School-of-Digital-Technologies/Research/Research-centres-and-groups/Digital-Safety-Lab>

<http://www.tlu.ee/en/School-of-Digital-Technologies>

Your Brief Biography

Including information about your studies, interests and publications if any

Edmund Laugasson is a doctoral student at the Tallinn University, School of Digital Technologies, Narva Road 29, 10120 Tallinn, Estonia. Born in 1976, he is expert in free software field - especially installing and configuring GNU/Linux and its applications. Also he holds master degree in teacher of informatics and has 15 years teaching experience.

His main focus of research is based on a different technology acceptance models but also free software assessment models. Less interest goes also other ethical and social issues of ICT (interoperability, information society, e-safety, licensing, etc). He holds master degree in teacher of informatics from Tartu University and is founding and board member of ALVATAL (Estonian Free and Open-Source Software Association), board member of NETICS (Network of Estonian Teachers of Informatics and Computer Science), supporting member of EPSFUG (European Parliament Free Software User Group), member of The Document Foundation and member of Digital Safety Lab of Tallinn University. He is consulting also number of educational institutions in Estonia about transition from proprietary to free software and Google Apps EDU solutions.

Papers:

- Edmund Laugasson, Mati Möttus „Free Software User Interfaces: Usability and Aesthetics“. HCI2015 (<http://2015.hci.international/>)
- Edmund Laugasson, Kaido Kikkas „File Formats Security – Proprietary vs. Open-Source“. HCI2014 (<http://2014.hci.international/>)
- Edmund Laugasson, Silver Püvi, Kaido Kikkas „Restructuring software systems in education and government“. WCCE2013 (<http://wcce2013.umk.pl/>)
- also some summerschools (both participating and being lecturer myself) and workshops has been made

Research area description

- **The main problem you are trying to tackle and its relevance**

Find an efficient way to exchange/transition of technology (software particularly) in a most less painful way and predict success of transition. For that purpose I have been created a strategy.

- **The aim of research**

The aim of my PhD thesis is to investigate and describe free software strategies to implement efficient, cost effective and secure information and communication technology management at state level in Estonia. As mostly the bottleneck in technology transition would be acceptance then I am focused to find solution there.

- **An outline of the current knowledge of the problem domain (What is the state-of-the-art in relation to existing solutions to the problem)**

Current technology acceptance models are tackling with innovation: no technology in use and then starting to use. Famous models are TAM, TAM2, TAM3, UTAUT, UTAUT2 etc. These models we can classify as vertical models as they dealing with innovation. My approach is more likely horizontal – one technology will be replaced by another one and innovation might happen as a special case.

In the European Interoperability Framework (EIF) introduction there is mentioned, that the Framework would be based on open standards and encourage the use of open source software (EIF, 2004, p. 5, p. 9, p. 24). Around the world, free software is already quite popular (Laugasson, 2010). In Europe are OpenDocument file formats also quietly spreading¹

There is also European Framework Programme 8, which is called Horizon 2020² now. In the document Proposal for a Regulation of the European Parliament and Council establishing Horizon 2020 - the Framework Programme for Research and Innovation (2014-2020)³ there is requirement (p. 44), that at 2020 should European ICT market share one third part of world's market. It would be shame if this will be mostly achieved by purchasing proprietary software licenses and not by real research, innovation, development. These goals (major activity lines at p. 45-46) can be much more efficiently and economically achieved by using free software – then there remains much more money for real research, innovation, development and also staff knowledge will be better improved.

Information and communication technology (ICT) is top priority also at the document Proposal for a Council Decision establishing the Specific Programme implementing Horizon 2020⁴ (p. 10).

The current situation in Estonia includes mostly proprietary software and its based solutions. Institutions are mostly using Microsoft, Adobe, Corel and other proprietary companies software and its data formats. Even educational software are often requiring Microsoft Windows operating system, which is not free. Public sector in Estonia is spending approximately 2,24 million € per year for proprietary office suite procuring. Estimated overall sum might be twice more. Therefore Estonia is depending too much on proprietary software and its data formats, which are not cost effective and have security weaknesses. Also software piracy is still a problem in Estonian and also rest of societies in the world (Hinnosaar, 2003).

In Estonia (and also other countries in the world) there is interoperability framework, which tells among other things about using open formats and preferring FOSS is must be policy in procuring software to state. But Estonian government has insufficient strategies to implement FOSS usage efficiently. Therefore there is a need to study and evaluate FOSS strategies and its usage at any level to achieve efficient and cost effective ICT management at the state level with also security in mind.

In the Estonian Interoperability Framework (2011), which is created using European Interoperability Framework in mind, is written: „*In the context of the framework, openness means that public sector takes into consideration the alternatives of open specifications, standards and software. When developing or ordering software, public sector should use the development methods of free software*“ (p. 11). When procuring software, free software alternatives MUST be taken into account (p. 11). When founding information systems and in public procurements' tender offers, alongside proprietary solutions, free software alternatives MUST be taken into consideration. Decision MAY be made in favour of free software, proprietary software or a combined solution, but in case other conditions are equal, software with a source code is preferred. Each case is decided on an individual basis (p. 35).

¹ <http://www.eionet.europa.eu/software/opendocument> , <http://www.odf-eag.eu/>

² <http://ec.europa.eu/research/horizon2020/>

³

[http://ec.europa.eu/research/horizon2020/pdf/proposals/proposal_for_a_regulation_of_the_european_parliament_and_of_the_council_establishing_horizon_2020_-_the_framework_programme_for_research_and_innovation_\(2014-2020\).pdf#view=fit&pagemode=none](http://ec.europa.eu/research/horizon2020/pdf/proposals/proposal_for_a_regulation_of_the_european_parliament_and_of_the_council_establishing_horizon_2020_-_the_framework_programme_for_research_and_innovation_(2014-2020).pdf#view=fit&pagemode=none)

⁴

[http://ec.europa.eu/research/horizon2020/pdf/proposals/proposal_for_a_council_decision_establishing_the_specific_programme_implementing_horizon_2020_-_the_framework_programme_for_research_and_innovation_\(2014-2020\).pdf#view=fit&pagemode=none](http://ec.europa.eu/research/horizon2020/pdf/proposals/proposal_for_a_council_decision_establishing_the_specific_programme_implementing_horizon_2020_-_the_framework_programme_for_research_and_innovation_(2014-2020).pdf#view=fit&pagemode=none)

Advances beyond the state-of-the-art in terms of your specific contribution and research plan (A description of the Ph.D. project's contribution to the problem solution)

Create appropriate strategy and hopefully also web-based tool (need help of programmers) to use implemented strategy in a very practical way. When creating evaluation metrics then test in practice – not only Estonia but also other countries need a solution how to tackle with technology transition issues.

Research questions

- how to change state staff working environment from using only proprietary software to use free software as much as possible
- how to increase people awareness about free software and its security, compatibility, benefit
- how to establish the usage of OpenDocument and Portable Document Format (PDF) at state level mentioned at State IT Architecture v1.01 (2007)
- how to solve any compatibility issues and increase awareness about it
- which methodology is best to describe transition to free software to be basis of chosen strategy

A presentation of any preliminary ideas, the proposed approach and achieved results

- Current status of the research plan
 - Acceptance Vector Strategy (AVS):
 - * Acceptance Vector Education (AVE) - concept of improved education system
 - * Acceptance Vector Framework (AVF)
 - Acceptance Vector Model (AVM):
 - uses horizontal approach, projected to 3D (Euclidean space):
 - time (user experience), $E \geq 0$ (quantitative)
 - functionality, $F \geq 0$, (quantitative)
 - perceived usefulness, $PU \geq 0$, $PU < 0$ (qualitative)
 - suitable for any kind of technology (even for new one – special case)
 - Acceptance Vector Plan (AVP) – step-by-step guide for transition using AVM
 - * Acceptance Vector Base (AVB) – monitoring system to ensure stability and sustainability
- A sketch of the applied research methodology (data collection and analyzing methods)

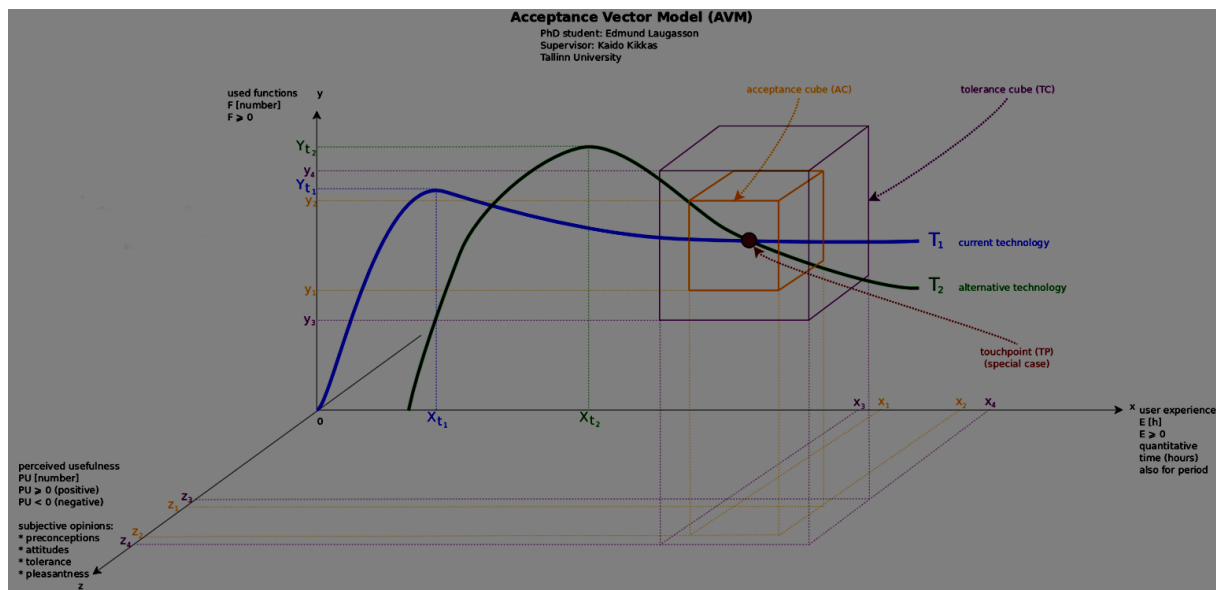

Figure 1: Acceptance Vector Model (Laugasson, 2014)

Expected achievements and possible evaluation metrics to establish the level of success of your results

Find appropriate mathematical and psychological approach supporting the strategy. Evaluation will be based on exact experiments of analyzing example technologies, e.g. software in public sector; programming languages in schools, etc. Hope to get some ideas from doctoral school about evaluation metrics.

Bibliographic References

1. Hinnosaar, Toomas, (2003), Software piracy and its impact on social welfare [WWW]. Retrieved from http://bankofestonia.info/pub/en/dokumendid/publikatsioonid/seeriad/kroon_majandus/_2003/_2003_3/_16-22hinnosaar.pdf
2. Zhu, Kevin Xiaoguo, Zhou, Zach Zhizhong, 2007 Lock-In Strategy in Software Competition: Open-Source Software vs. Proprietary Software [WWW]. Retrieved from <http://isr.journal.informs.org/content/early/2011/06/16/isre.1110.0358.abstract>

Expectations and motivation to attend Doctoral Consortium

Discuss over presented strategy and its components and get feedback of it. Discuss over mathematical (MDS – multidimensional scaling) and psychological (perceived usefulness, resistance of changing technology) background containing in strategy. Finding possible solutions to create web tool. Filling some missing or not completely established gaps, e.g. evaluation metrics examples. Also need help of programmers.

Possibly also discuss over methodologies of free software assessment methods and possible strategies. Establish international contacts between researchers and scientists and possible cooperation (writing papers together). Also revamp research questions.

Also establishing proper way for communication in present (at least during doctoral school) and future. E-mail seems to be already a bit outdated, old-fashion and quite limited, which obviously works in some cases but often takes more time and needs more attention to layout, which is actually often not needed for collaboration. Also mailbox is getting full of sent attachments as people do not know much about cloud storage opportunities unfortunately. In mailing list I proposed Telegram - <https://telegram.org/> - new era in messaging: secure (256-bit AES encryption), free and open-source software, free API's available (possible to write different bots and also several bots available in internet if needed), cloud-based way to communicate. Up to 1,5 GB per file can be uploaded, overall amount is not limited. Text-based chat, also voice messages possible to post. All content are kept until user decides to delete. Files (documents, images, etc) are easy to post – just drag and drop to the app window or share in smart device. There is possible to create group with up to 200 members and channel with unlimited members. There is possible to create autojoin link for group or channel. Username is mobilephone number (later can be also real username to choose) and password is confirmation code sent by SMS and through Telegram itself. Available for many platforms, especially comfortable to use in smart devices (integrates well with different services in smart devices) – all conversations will be synced across devices and viewable also in web. So, also web-based version available. Special secure end-to-end encrypted chat also possible (will be not synced across devices). Also portable version available – no need for administrative permissions.

I remember last time at 2014 was a problem how to share information among participants at doctoral school in Druskininkai. Here is one affordable and comprehensive solution I propose. Creating group and/or channel takes few minutes and is pretty easy. By the way – content uploaded to Telegram is not searchable from internet, which might be also important.

I also hope that all presented posters and ideas will be collected and saved for future reading. Because during doctoral school each student will tackle with her/his dissertation topic and there might be not much time to read/analyze other posters. One opportunity is to share them through Telegram but it might be also possible to put them privately onto web (e.g. university one) of somewhere cloud storage (e.g. <http://www.free-online-backup-services.com/> - e.g. MegaSync (50 GB free storage) is one good choice).

Yours faithfully,

Edmund Laugasson

doctoral student, analyst, sysadmin

Digital Safety Lab, School of Digital Technologies, Tallinn University, Estonia

Mobile phone: +372 5280479, send a telegram <https://telegram.me/edmundlaugasson>

PROJECT METRICS AND TOOLS IN AGILE SOFTWARE PROJECTS

Mäkiaho Pekka

2nd year of doctoral studies
Mäntyveräjätie 3 d 36
36200 Kangasala, Finland
pekka.makiaho@uta.fi

Your Brief Biography

I have a background in software industry as a developer and project manager. I worked in software business, most of the time in Nokia Mobile Phones, from mid-90's until 2009 when I started to do my supplementary studies and to give lectures on the University of Tampere.

I am interested in software developing and project management.

I am on my second years of my PhD studies and I have three publications on the subject [7],[8],[9].

Research area description

A software project can be considered a success if it keeps the schedule, stays in budget's limit and the original requirements are implemented during the project [1],[11],[13]. According to researches [2] the projects rarely fits these criteria.

Project management consists of initiating the project, planning, execution, monitoring and controlling the project and closing the project [10]. One of the most important reason that a project fails is poor reporting of the project's status [10]. Because of the poor reporting, the management does not know the state of the project and thus does not execute the right actions. Therefore, it is failed on the monitoring and controlling phase.

A software metric is the measurement of a particular characteristic of a software or the measurement of a software project and process. Goodman [3] defines software metrics to be "the continuous application of measurement-based techniques to the software development process and its products to supply meaningful and timely management information, together with the use of those techniques to improve that process and its products".

Software metrics can be categorized into controlling and predicting metrics: controlling metrics are related to software processes and predicting metrics to software products [9]. The controlling metrics can also be divided into process and project metrics depending on whether they are measuring the software process, and thus supporting strategic decisions, or whether they are measuring an individual project and supporting tactical decisions [3]. In this research, we use terms product metric, project metric and process metric.

Software metrics have not been standardized and thus the tool support for collecting and analyzing data is rather limited [12]. More and more software projects [2] are applying agile methods. One of the weakness in agile software developing is the lack of metrics [4][6].

Research questions

In this research, we will observe project metrics in agile software development: what the different metrics tell about the project's state, how the metrics forecast the result of the project, and how the project management could benefit the metrics while making decisions. We will also try to find an answer on what are the metrics of which observing a project management tool should support.

The first research question is to clarify software metrics on the next fields: version control, risk management, testing and requirements; and describe what the metrics in each area tell about the project's state, forecast and the actions that should be done in the project.

The second research question is how the current project management tools support the observing of project metrics. The aim is to make a recommendation of which metrics an SPM-tool should make available, to develop a prototype of this kind of tool, and evaluate it.

The third research question is to investigate the dependencies between the metrics and find out how combining the metrics could be used for seeing the big picture of the project's state, for forecasting the project and for finding the correct actions during the projects.

Research methods and materials

The research method is design research; in the research, a metrics management tool (MMT) will be designed and implemented and the outcome will be evaluated.

The research materials will be collected by observing students on Software project courses: Project work (PW) and Software project management (SPM). The students are interviewed while they are implementing the projects; students fill Moodle-questionnaires and data is collected automatically from version control tools. Moreover, the project managers of the students' teams send pre-formatted weekly reports in which there are given quantitative information on the projects like the requirements in each state, test cases, and used/left working hours.

The project work course is also taken to use in implementing and evaluating phases of the MMT, which will be constructed. Different versions are implemented and will be taken to use in the courses. The data will be collected automatically via the tool and by questionnaires and interviews.

The results to be expected

Even the metrics have been used in software developing already 40 years, the metrics have not much applied in agile methods, and there is not enough researching especially on project metrics in agile software developing [5]. As a result of this research we will give a recommendation on those metrics of which observing a project management tool should support. We will also give guidelines how to utilize these metrics in project controlling in agile software developing.

A presentation of any preliminary ideas, the proposed approach and achieved results

There have been three publications on this research. The first, *Tool usage in students' software projects* [7], concentrated on the tools that were used in student's projects. The second observed the version control usage in the projects [8] and the third is about the metrics in general [9].

The first version of MMT-tool was created on the project work courses fall 2014. This version had some major bugs and thus the developing was continued on the summer semester 2015 in a one student's personal project. Even that version had some showstoppers and the developing was started on the top of new framework fall 2015. The target is to start the piloting on the PW-courses at February 2016. The results of these developing and piloting phases will be published in eLearning-conference at Bratislava in September 2016.

Currently, we are collecting data and preparing a paper to CompSysTech'16 on software requirements and how the number and the statuses of the requirement change during the projects in agile software projects.

On the beginning of the research, I concentrated more on static time- and cost based project metrics. However, it might be that the trend in the project management will be metric based management [15] and the metrics must be set for each project and even for each stakeholder separately. The metrics may even have to be changed and weighted during the project.

I have also found that the project metrics can't be handled separately but they should be combined with product metrics like the lines of code.

Bibliographic References

1. Blaney, J: Managing software development projects, *PMI Seminar/Symposium* (Oct 7–11, 1989), 410–417.
2. The Standish group, *CHAOS Manifesto 2013*. The Standish Group International, 2013.
3. Goodman, Paul, *Practical Implementation of Software Metrics*, McGraw Hill, London, 1993.
4. Shahir, H. and Daneshpajouh, S. and Ramsin, R.: *Improvement Strategies for Agile Processes: A SWOT Analysis Approach*. Department of Computer Engineering, Sharif University of Technology, Tehran, Iran, 2008.
5. Kulas H., *Product metrics in agile software development*, University of Tampere, School of Information Sciences M.Sc. thesis, Jan 2012.
6. Kupiainen, E. and Mäntylä V. and Itkonen J.: *Why are industrial agile teams using metrics and how do they use them?* Proceedings of the 5th International workshop on Emerging Trends in Software Metrics. ACM, 2014, pp. 23–29.
7. Mäkiaho, P. and Poranen, T.: *Tool usage in students' software projects, 2012*, Proceedings of INSPIRE, 2012, 63-76.
8. Mäkiaho, P. and Poranen, .T and Seppi, A.: *Version Control Usage in Students' Software Development Projects*, Proceedings of CompSysTech 2014, 8 pages.
9. Mäkiaho, P. and Poranen, T. and Seppi, A.: *Software Metrics in Students' Software Development Projects*, Proceedings of CompSysTech 2015, 8 pages.
10. *A Guide to the Project Management Body of Knowledge*, 5th edition. Project Management Institute, 2013.
11. Roo, P., Controlling software development projects. *Software Engineering Journal-Controlling software projects archive*. **1** (1), Jan. 1986, 7-16.
12. Sommerville, I., *Software Engineering*, 9th edition. Addison-Wesley, 2010.
13. Weitz, L.: How to implement projects successfully, *Software Magazine*, **9** (13), 1989, 60–69.
14. Why Software Fails. <http://spectrum.ieee.org/computing/software/why-software-fails>. Referred 13.11.2015
15. *Project Management Metrics, KPIs, and Dashboards*, 2nd Edition. Wiley 2013.

Expectations and motivation to attend Doctoral Consortium

I would really need an outsider's viewpoint here. To which direction to go and how to narrow the scope. I see that I find something new every time I come back to this. However, the limits should be set somewhere.

I am also looking forward to meet an expert on project management area eve specifically on metrics area.

COLLABORATIVE LEARNING USING ICT CREATION, IMPLEMENTATION AND EVALUATION OF PEDAGOGICAL SCENARIOS IN SECONDARY SCHOOLS

Naujokaitiene Justina

2nd year of your doctoral studies
Vytautas Magnus University, Department of Education
Jonavos g. 66, Kaunas. LT-44191, Lithuania
j.naujokaitiene@smf.vdu.lt

Your Brief Biography

I am a PhD student in the Department of Education at the Vytautas Magnus University, Lithuania. I hold bachelor's and master's degrees in psychology. My research interests focus on organizational change and behavior, learning at work, and information technology (IT)-based and technology-enhanced learning.

Publications:

Naujokaitienė, Justina; Teresevičienė, Margarita. Extension of Technology Acceptance Model while Integrating TEL into Business Organization. *Aukštųjų mokyklų vaidmuo visuomenėje: iššūkiai, tendencijos ir perspektyvos*. ISSN: 2029-9311. 2014, Vol. 1, No. 3. p. 152-157. [IndexCopernicus].

Abromavičienė, Daiva; Teresevičienė, Margarita; Naujokaitienė, Justina. Support System of Technology Enhanced Learning in an Educational Institution. *European Scientific Journal*. ISSN: 1857 – 7881 (Print) e - ISSN 1857- 7431 7431. May 2014 edition. Vol.10, No. 3, p. 142-155. [IndexCopernicus].

Naujokaitienė, Justina; Teresevičienė, Margarita.; Zydziunaite, Vilma. Organizational Support for Employee Engagement in Technology-Enhanced Learning. *SAGE Open*. ISSN: 2158-2440. 2015. Vol. 1 No. 9, p. 1-9. [SCOPUS].

Research area description

Paradigm of traditional education is no longer suitable for nowadays secondary school. In order to achieve set goals, schools must keep up with the educational and technological innovation. Information and communication technologies (ICT) cannot simply supplement traditional teaching and learning activities, because the use of ICT exchanges teaching and learning objectives and techniques. After all, it is not possible to affirm that ICT changes teaching and learning process turning it more productive or improve students' achievements. It is not a magic wand that solves all pedagogical challenges of today's knowledge-based society (Bhasin, 2012). The question is whether schools, looking to the educational goals, selects the proper training methods and properly complements them with ICT.

ICT in the learning process are connected with positivistic pedagogy, which says that learner should be given needed tools and support in their learning experiences (McRobb et al., 2007). All this process should be developed by teacher.

If positivism is based on realistic ontology, then constructivism says that reality is constructed. According to constructivists, the truth can be an agreement between those who are involved in to learning construction and must be oriented to the process in which useful constructs are developed (McRobb et al., 2007). Ontologically collaborative learning and usage of ICT in educational process is analyzed basing on constructivistic perspective.

According to Vygotsky (1978) pupils in collaboration, rather than learning individually, can make a higher intellectual level tasks. The reason is that the pupils are faced with different interpretations, explanations or answers, so it is needed to review taken learning decisions. Collaborative learning includes a variety of educational practices, which states that the interaction between learners is a key factor for learning, but not excluding factors such as learning materials and learner interaction with a teacher (Popescu, 2012).

In research works, benefits of the use of ICT and collaborative learning for educational process are described separately (Susman, 1998; Ertmer, 1999; Becker, 2000; Valtonen, 2011). Researchers are looking for ways to improve the traditional process of education, regardless of the fact that the new solutions and new knowledge may arise from the use of ICT (Cox and Marshall, 2007).

The methods of collaborative learning covers team work when pupils are actively sharing information; discussing while becoming involved into the learning process. There can be used various strategies in the time of learning, which helps to achieve common goal, which is the responsibility of all learning group members (Garcia-Valcarcel et al., 2014). Active sharing while working in small groups determines not only greater interest in learning, but also develops critical thinking (Gokhale, 1995).

Siraj-Blatchford (2007) suggested the main factors that scaffold the success in collaborative learning: good group relationships, clear learning tasks, supportive collaboration between group members and teaching about effective group dynamics. When pupils are collaboratively solving tasks they meet the complex cognitive, meta-cognitive and strategic challenges such as organizing or getting knowledge, modeling and supervising decisions, presenting convincing ideas, assessing and reflecting about learning process (Ge and Land, 2003; Wegerif, 2006; Bulu and Pedersen, 2012). In this process it is important that pupils are responsible for their own and each other learning (Dooley, 2008).

Teachers are encouraged to organize an active learning process integrating ICT; however, unfortunately there are no guidelines about how to do that. What kind of teaching method will be used and whether or not to use ICT in the lesson is only a teachers' decision. Teacher who is more into traditional education will use different ICT than the teacher who lean on constructivist ideas. We can already tell that teacher's role is very important while presenting ICT in the lesson for the pupils (Cox, Preston and Cox, 1999; Ertmer, 1999), and choosing how they will be used during the lesson (Williams et al., 2000).

In Lithuania collaborative learning was analyzed in different context: G. Gedviliene – traditional learning context, V. Mazeikiene and G. Valunaite-Oleskeviciene – foreign language learning context, and A. Ramanauskaite and R. Masaityte - Apuokiene – vocational education context. ICT researches are also very relevant and fast developing research area. Unfortunately there are very few researches analyzing integration of ICT using unconventional learning methods.

Aim of the research – To promote collaborative learning using ICT in secondary schools by creating a pedagogical scenario, implement and evaluate it.

Research questions:

1. What is the essence of collaborative learning using ICT?
2. What kind of learning scenarios are there?
3. How ICT are developed and implemented into the learning process?
4. Is the implementation of collaborative learning pedagogical scenario using ICT makes learning process more effective than traditional learning?

Methodology of the research (methods and implementation)

While trying to answer the question what is the essence of collaborative learning using ICT, it is important to make an analysis of international, European Union and national documents, regulating education in schools, scientific works, other scientists dissertations and articles. This analysis will also help with development of different educational scenarios using ICT. Also, following the analysis of various resources, the questionnaire for the state of art research will be developed; aimed to find out are teachers using ICT while pupils are involved in collaborative learning, what kind of learning scenarios there are, how they are developed and implemented into learning process.

According to the statistical data of Lithuanian Ministry of Education and Science and Education Centre of Information Technologies (2014) there are 30,552 teachers in Lithuania. The estimated sample size for quantitative study (State of art study) should be 379 participants (sampling error - 5% confidence level - 95 %). Research participants will be selected using nested sampling. Using this method of sampling there are selected not individual members but all groups, for example - teachers community in secondary school. All teachers, participating in the research will fill in on-line research questionnaire.

The aim of the state of art research is to find out whether the teachers in secondary education schools apply collaborative learning and if they felt confident to use ICT in this context. It is also intended to analyse what kind of pedagogical scenarios are being used to implement educational activities using ICT. The sample of this research will be 500 secondary school teachers. Using the larger sample there is intended to maintain the representative sample size, considering that the part of the questionnaires can be filled improperly.

In order to assess if the implementation of collaborative learning pedagogical scenario using ICT makes learning process more effective than traditional learning there will be quasi - experiment implemented. While the quasi – experiment three pedagogical scenarios will be implemented in three groups of secondary school pupils. Before and after the implementation of learning scenario there will be assessed the change of student grades, measured collaboration skills, development of critical thinking, involvement into learning process. After a quasi - experiment, findings summarized and recommendations will be made.

Time table of the project implementation

- 1st semester: review of recent studies on project topic.
- 2nd semester: deciding on research aim and main goals.
- 3rd semester: developing research methodology.**
- 4th semester: quantitative research.
- 5th semester: quasi-experimental research.
- 6th semester: summarizing results of the research.
- 7th semester: making conclusions.
- 8th semester: preparing summary of research project.

Bibliographic References

1. Becker, H. J. (2000). Findings from the teaching, learning, and computing survey: Is Larry Cuban right? *Education Policy Analysis Archives*, Vol. 8 No. 51.
2. Bhasin, B. (2012). Integration of Information and Communication Technologies in Enhancing Teaching and Learning. *Contemporary Educational Technology*, Vol. 3, No.2.
3. Bulu, S. T., Pedersen, S. (2012). Supporting problem-solving performance in a hypermedia learning environment: The role of pupils' prior knowledge and metacognitive skills. *Computers in Human Behavior*. Vol. 28, p.p. 1162-1169.
4. Cox, M. J., Marshall, G. (2007) Effects of ICT: Do we know what we should know? *Education and information technologies*, Vol. 12, No. 2, p.p. 59 - 70
5. Cox, M.J., Preston, C., & Cox, K. (1999) What Motivates Teachers to use ICT?. Paper presented at the British Educational Research Association Conference. Brighton.
6. Dooly, M. (2008). Constructing knowledge together. In Dooly, M. (ed.) *Telecollaborative language learning. A guidebook to moderating intercultural collaboration online*, Bern: Peter Lang.
7. Ertmer, P. (1999). Addressing first- and second-order barriers to change: Strategies for technology implementation. *Educational Technology Research and Development*, Vol. 47 No. 4, p.p. 47–61.
8. Garcia-Valcarcel, A., Basilotta, V., Lopez, C. (2014). ICT in Collaborative Learning in the Classrooms of Primary and Secondary Education. *Comunicar*, Vol. 42. doi: 10.3916/c42-2014-06.
9. Ge, X., Land, S. M. (2003). Scaffolding students' problem-solving processes in an illstructured task using question prompts and peer interactions. *Educational Technology Research and Development*, Vol. 51 No.1, p.p. 21-38.
10. Gokhale, A. A., (1995). Collaborative learning enhances critical thinking. *Journal of technology education*, Vol. 7., No. 1.
11. McRobb, S., Jefferies, P., Stahl, B. C. (2007). Exploring the Relationships between Pedagogy, Ethics & Technology: building a framework for strategy development. *Technology, Pedagogy & Education*, Vol. 16, No 1, pp. 111-126.
12. Popescu, E. (2012). Providing collaborative learning support with social media in an integrated environment. *World Wide Web*, Vol. 17, p.p 199-212.

13. Siraj-Blatchford, I. (2007). Creativity, communication and Collaboration: The Identification of Pedagogical Progression in Sustained Shared Thinking. *Asia-Pacific Journal of Research*, Vol. 1, No. 2, p.p. 3-23.
14. Susman, E. B. (1998). Co-operative learning: a review of factors that increase the effectiveness of computer-based instruction. *Journal of Educational Computing Research*, Vol. 18 No. 4, p.p. 303–322.
15. Valtonen, T. (2011). An insight into collaborative learning with ICT: Teachers' and students' perspectives. Doctoral dissertation.
16. Vygotsky, L. (1978). Interaction between learning and development. In Vygotsky, L, *Mind in Society*, pp. 79-91. Cambridge, MA: Harvard University Press.
17. Wegerif, R. (2006). A dialogic understanding of the relationship between CSCL and teaching skills. *International Journal of Computer Supported Collaborative Learning*. Vol. 1 No. 1, p.p. 143-157.
18. William, D., Coles, L., Wilson, K., Richardson, A., & Tuson, J. (2000). Teachers and ICT: Current use and future needs. *British Journal of Educational Technology*, Vol. 31, p.p. 307-320.

Expectations and motivation to attend Doctoral Consortium

Doctoral Consortium is my opportunity to present my doctoral thesis, although in a very early stage. I hope that presenting and discussing my thesis during the doctoral consortium will help me to focus my research questions and to improve methodology. My main motivation for attending the Doctoral Consortium is to discuss with senior researchers the contributions of my PhD and get feedback on my research. Furthermore I think that the possibility to exchange my ideas with the other doctoral consortium student participants will also provide me with insight in their interesting works.

MODEL OF DEVELOPING CT IN COMPREHENSIVE SCHOOL LESSONS

Palts Tauno

2nd year of doctoral studies
University of Tartu
Tartu, Juhan Liivi 2, 50409, Estonia
tauno.palts@ut.ee

Biography

Tauno Palts graduated Infotechnology in 2009 and received his Master of Arts degree in Teacher of Mathematics and Informatics in 2011 from the University of Tartu. In 2014 he started his doctoral studies in Informatics at the University of Tartu. His current research themes include teaching CT in comprehensive school.

He has worked as a mathematics and informatics teacher in a secondary school in Estonia and has been a teacher assistant in England. Mr. Palts started working at the University of Tartu as an Assistant of Didactics of Informatics in 2012.

Research area description

- The main problem you are trying to tackle and its relevance

The main problem is that there is no practical model of developing CT (CT)) in the comprehensive school.

- The aim of research

Aim of the research is to find the best practices developing CT in a school lesson and form a model that describes and can be used to develop CT in comprehensive school.

- An outline of the current knowledge of the problem domain (What is the state-of-the-art in relation to existing solutions to the problem)

There is a high demand for qualified ICT practitioners in the European labor market. Having your first computer, experience of doing something by myself: solving computer-related problems (helping others), building a computer, software developing or trying to make a computer game, web page design has a big influence on starting ICT studies and being successful at it (Kori et al., 2014).

Therefore, educational research is needed to introduce the principles of computer science already at comprehensive school level in order to raise the interest in as well as the awareness of studying computer science.

Wing states that CT is a fundamental skill for everyone, not just for computer scientists. Some authors even argue that we should add CT as every child's analytical ability, just like reading, writing, and arithmetic. (Wing, 2006)

CT is the thought processes involved in formulating problems and their solutions so that the solutions are represented in a form that can be effectively carried out by an information processing agent" (Wing, 2006).

- Advances beyond the state-of-the-art in terms of your specific contribution and research plan (A description of the Ph.D. project's contribution to the problem solution)

Three CT approaches (Interaction between a Human and a Computer, Conceptual Model, and Engineering Design) look at CT from different perspectives and a model for learning CT can be created which includes the various dimensions of CT for learning CT at comprehensive school level.



Figure 1. Model of Learning CT (Palts & Pedaste, 2015)

Palts and Pedaste (2015) represented a revised model of learning CT, which can be used to create scenarios to teach CT in comprehensive school lessons. The revised model of learning CT (Figure 1) includes three main components derived from previous models of CT:

1. Interaction between a Human and a Computer in the model of learning CT has a vital role and is presented in (Figure 1) as the centre of the model (Wing, 2006).
2. Middle circle consists of the concepts of CT from the conceptual model of CT (Wenchong et al., 2014) Five core elements of CT (structuralization, formalization, optimization, association and interaction, reuse or sharing) are included in the model because those five components of CT can be taught in various lessons, in various key stages and involve the core elements of CT. In (Figure 1) those five elements can be seen surrounding the centre of interaction of humans and computers. The five core elements can be rotated around the centre and used dynamically without any fixed order.
3. Outer circle consists of problem solving steps from the engineering design process (Massachusetts Department of Education, 2006). 8 steps are included in the model to go through all the steps that occur during the process of learning CT. The first step in the process of learning CT should be identifying the problem. The arrow pointing from step 1 to step 2 in Figure 4 indicates that after the problem is identified, research needs to be done, and after that, possible solutions are developed. The steps are following each other in a linear way and the various steps more or less include the core elements of CT. The circular arrows indicate that when one problem is solved (step 8), a new one can be started from the beginning (step 1).

A presentation of any preliminary ideas, the proposed approach and achieved results

- Current status of the research plan

Research plan (Figure 2) consists of three parts, in which each part ends up with an article. First article is about getting overview of the field of CT and forming a model of learning CT. Second article is about pilot study – observing lessons and creating scenarios to teach CT. Third article is about complemented scenarios, project analyses and complementing model so that it could be used to create scenarios teaching CT in comprehensive school lessons.

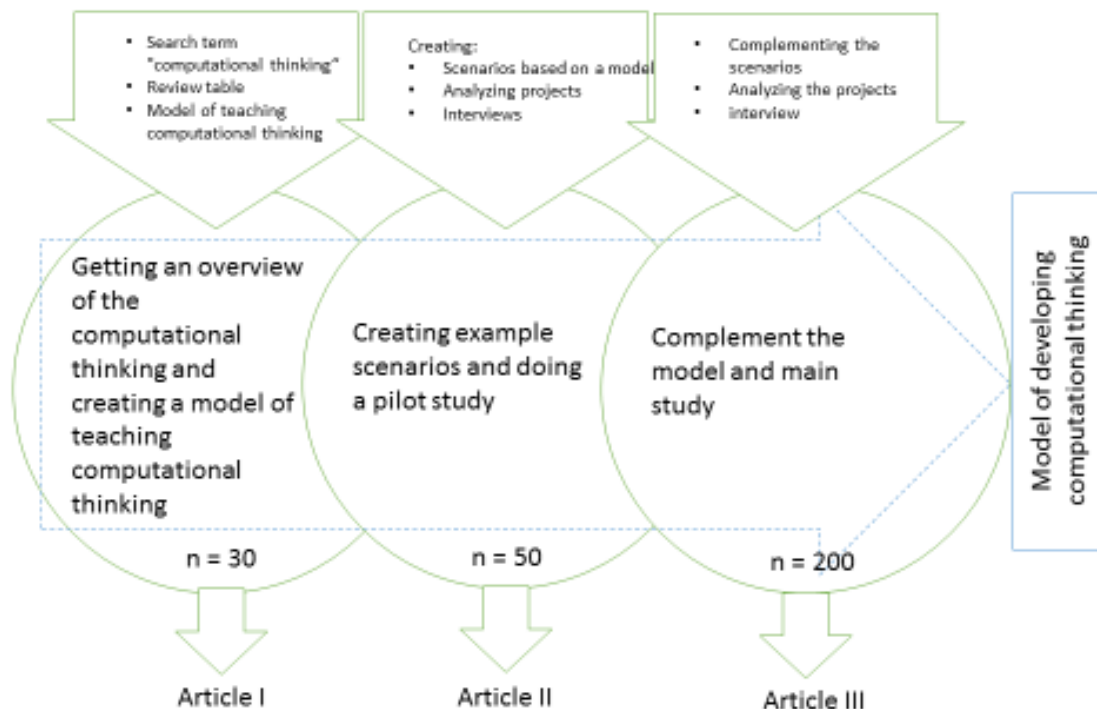

Figure 2. Research plan

- A sketch of the applied research methodology (data collection and analysing methods)
 Three main steps in pilot study:

1. Investigating CT taught naturally at mathematics lessons.
 - Structured observation – difference between need and reality
2. Solving the practical need based on a model
 - Creating exercises and lesson plans for the mathematics lessons developing CT.
3. Evaluate development of CT
 - Doing a study in the mathematics lessons, which include the new exercises and lesson plans. Expected achievements and possible evaluation metrics to establish the level of success of your results

Dr. Scratch could be used to assess the level of developed concepts of CT in the Scratch projects .

Bibliographic References

1. Massachusetts Department of Education. (2006). Massachusetts science and technology/engineering curriculum framework. Retrieved from. Massachusetts Department of Education <http://www.doe.mass.edu/frameworks/scitech/1006.pdf>.
2. Palts, Tauno; Pedaste, Margus (2015). Model of Learning CT. IFIP TC3 Working Conference "A New Culture of Learning: Computing and next Generations" (211 - 221). Vilnius University
3. Wing, J. M. (2006). CT. Communications of the ACM, 49(3):33 – 35.
4. Wenchong, S., Maohua, L., & Hendler, P. (2014). Computational Features of the Thinking and the Thinking Attributes of Computing: on CT. Journal Of Software (1796217X), 9(10), 2507.

Expectations and motivation to attend Doctoral Consortium

Motivation is to meet young scientists, who are interested in computer science education and get feedback for the research design.

Main goal would be to find interventions to get to know the level of students' knowledge of CT concepts before specific training in order to see the development of CT.

PHYSICAL COMPUTING IN COMPUTER SCIENCE EDUCATION

Przybylla Mareen

3rd year

University of Potsdam, Didactics of Computer Science

August-Bebel-Str. 89

14482 Potsdam, Germany

przybyll@uni-potsdam.de

Biographical Information

Mareen Przybylla is research assistant and PhD candidate at the professorship for Didactics of Computer Science at the University of Potsdam, Germany. In 2012 she completed her studies in English and Computer Science with a Master's of Education. Her main research interest is on physical computing in computer science education and its effects on learning. She is active in research on computer science education at high school level and has published parts of her work in conference proceedings of national and international conferences, e.g. Constructionism, INFOS ("Informatik und Schule" – engl.: Informatics and School), ISSEP, KeyCIT and WiPSCe. Mareen is a member of the German Informatics Society (Gesellschaft für Informatik e.V. (GI)). Within the GI she is member of the executive committee of the special interest group "Computer Science Education in Berlin and Brandenburg" and a member of the special interest group "Didactics of Computer Science". She brings practical experience in teaching, teacher education and professional training and is in frequent lively exchange with the national and international community. As common in Germany, she is not enrolled in a PhD program, but does an individual doctorate as an internal with a full time position. She has scheduled herself a timeline that aims at finishing 2017.

Selected publications:

- Przybylla, M. and Romeike, R. *My Interactive Garden – A Constructionist Approach to Creative Learning with Interactive Installations in Computing Education*. Constructionism: Theory, Practice and Impact. Proceedings of Constructionism 2012, (2012), 395-404.
- Przybylla, M. and Romeike, R. *Physical Computing im Informatikunterricht*. Informatik erweitert Horizonte, Lecture Notes in Informatics (2013), 137-146.
- Przybylla, M. and Romeike, R. *Key Competences with Physical Computing*. Proceedings of Key Competencies in Informatics and ICT 2014, Universitätsverlag Potsdam (2014).
- Przybylla, M. and Romeike, R. *Overcoming Issues with Students' Perceptions of Informatics in Everyday Life and Education with Physical Computing - Suggestions for the Enrichment of Computer Science Classes*. ISSEP 2014 - Informatics in Schools. Teaching and Learning Perspectives, (2014), 9-20.
- Przybylla, M. and Romeike, R.: *Physical Computing and its Scope - Towards a constructionist Computer Science Curriculum with Physical Computing*. Informatics in Education 13,2 (2014), 241–254.
- Przybylla, M. and Romeike R. *Concept-Maps als Mittel zur Visualisierung des Lernzuwachses in einem Physical-Computing-Projekt*. Informatik allgemeinbildend begreifen, Lecture Notes in Informatics (2015), 247-256.

Research area

Until recently, software development dominated the creative and design-oriented parts of computer science education. In most schools, the desktop computer is the entry point into the virtual world of computer science. Outside schools, however, traditional desktop computers are increasingly often replaced by ubiquitous computing systems, often containing embedded systems that are hidden inside various intelligent devices (e.g. Rusk et al. 2008; Stager 2009). The creation of such systems is supported by large availability of suitable hard- and software tools for all purposes and experience levels, which is also reflected in the maker movement [3]. Makers are engaged in do-it-yourself projects that often include computing skills besides crafting and using electronics. Those activities, where interactive objects are designed and created, can be referred to as 'physical computing'. Interactive Objects are programmed, tangible media that communicate with their environment – be it humans, their

surroundings or other interactive objects – through sensors and actuators (cf. Przybylla and Romeike 2012). Examples for such interactive objects and installations range from interactive jewellery and clothes over intelligent toy pets to room-filling installation arts. Physical computing has a comparatively long tradition. Blikstein’s historical overview of physical computing devices dates back to the 1980s when the LEGO/Logo platform was developed [5]. Within the physical computing community tinkering is very popular. This includes two basic activities: exploring existing systems and expressing ideas in creating new systems. This way, constructionist learning [6] takes place: guided by their own interest and for a personally relevant purpose, learners actively construct knowledge. In physical computing activities, students learn with and about interactive computing systems by creating concrete, tangible products of the real world that arise from their own imagination and that they can show around and be proud of in a constructionist sense. With physical computing, constructionist learning is raised to a level that enables students to gain haptic experience and thereby concretizes the virtual [7]. Students create real interactive constructions applicable for the purposes of embedded and cyber physical systems and thus learn in authentic contexts [3], [8]. Such learning is described as highly interactive because both, digital media and the real object, immediately reflect learning success and problems and thus allow each learner to learn at his or her own pace based on individual learning goals. Ackermann, in reflection of the Piagetian constructivism and Papert’s constructionist theory of learning, highlights Papert’s view that “[...] “diving into” situations rather than looking at them from a distance, that connectedness rather than separation, are powerful means of gaining understanding” [9]. This is exactly what happens in physical computing activities: in designing and realizing their interactive objects, learners dive into the role of inventors. They are connected with their artefacts, even physically, as they can see them, but also touch them, play with them and share them with their peers. Finally, through making their objects, they construct and constantly reconstruct knowledge. As Stager puts it, in physical computing projects “[...] knowledge is constructed and the best way to ensure learning is through the deliberate construction of something shareable outside of one’s head” [2]. However, in computer science education it is a rather new phenomenon. Recently, physical computing was integrated into computer science curricula, e.g. England’s CAS curriculum [10] or the new computer science curriculum of Berlin/Brandenburg, Germany [11].

In contrast to other hardware-centred approaches such as robotics activities, physical computing changes direction: it encourages learners to become creative inventors – something that enthuses teachers and students alike [1], [4]. However, despite the potentials to offer modern state-of-the-art CS learning experiences, physical computing is often used as ‘just another teaching method’ to introduce students to topics and contents already existing in the curricula. But physical computing has a lot more to offer: sensing and actuating technology, hardware in general and embedded systems (feedback and control, concurrency, trade-offs, etc.) are no longer discussed on a theoretical level, but actually “done” in class. Physical computing integrates many methods and underlying ideas of embedded systems, cyber physical systems, smart objects and IoT devices [12]–[16] – technologies that are pervasive in students’ everyday lives. Thus, the aim of this research is to situate physical computing within the field of computer science education. Questions that need answering in this context are:

- Which aspects of physical computing are appropriate for CS education at school?
- What are the potential benefits and drawbacks of physical computing in school student learning?
- How can physical computing be implemented most efficiently in the computer science classroom?

Research Design

The preparation of learning contents and competence goals for teaching physical computing at school requires a thorough examination of the topic. From the contents identified as relevant in this topic are, appropriate contents and competence goals for different levels at school need to be identified and didactically prepared. Kattmann et al. argue that central aspects of lesson planning such as learning goals or the perspectives of learners (e.g. preconceptions, attitudes or interests) are often only considered after the clarification and analysis of the science subject matter, if considered at all [17]. They see a clear gap between science education research and science instruction practice, which they seek to close with the model of educational reconstruction (MER). In this model, the clarification of the science subject matter and the investigation of student perspectives both influence the design and evaluation of learning environments. This way, students’ conceptions are considered and contents are related to everyday ideas and experiences of the learners (see Figure 1). The model was later refined by Duit [18] to also include teacher perspectives and evaluation of teaching and learning environments

and thus involves research in the classroom (see Figure 2). However, as Diethelm et al. point out, computer science differs from other science subjects in goals, knowledge structure and teaching methods. They have therefore adapted and extended the MER for computer science education (see Figure 3) and described its application in detail [19].

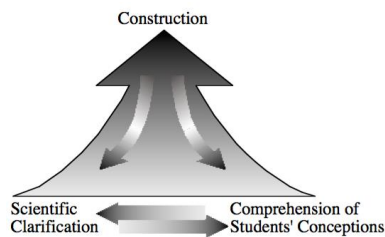

Figure 2. Model of Educational Reconstruction (MER) [17]

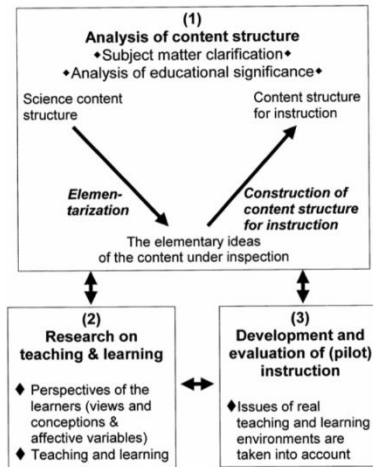

Figure 3. Refined Model of Educational Reconstruction [18]

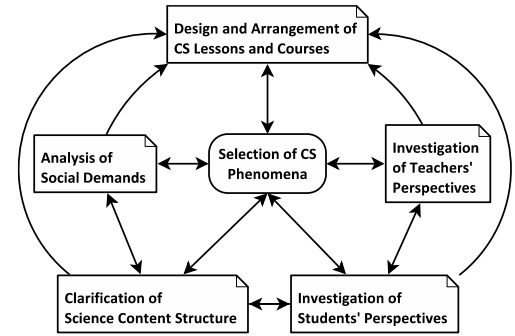

Figure 4. Educational Reconstruction for Computer Science Education [19]

In addition to the aspects mentioned in the science models, they highlight the role of context and phenomena “to motivate the students, to open connections to prior knowledge or to show application situations of the intended knowledge.” [19]. This approach ties in with the ideas of Piaget’s constructivism, i.e. that learning means to build knowledge structures from interpreting new information (e.g. acquired through playing with things, reading books or listening to people) based on existing knowledge and experience. Further, in the MER for CS education, social demands are analysed. This is to verify the educational significance of the intended learning content. The MER for CS education is promising as a research framework, as it does not only focus on the content structure suitable for teaching, but also emphasizes the general “*Design and Arrangement of CS Lessons and Courses*”, taking into account intentions, contents, teaching methods and media [19]. The following section illustrates how the MER for CS education will be applied in order to situate physical computing in computer science education.

Educational Reconstruction for Situating Physical Computing in CS Education

As the idea of my research is not to develop a lesson or course plan, but rather to situate physical computing within the field of computer science education, the aspects of educational reconstruction will be regarded from a wider perspective than focused on a single phenomenon.

Selection of CS Phenomena

A central question of the MER for CS education in this context is, which CS phenomena can be explained with contents and methods from physical computing. It will therefore be examined how such phenomena can be identified. Diethelm et al. use the understanding of phenomena as suggested by Humbert an Puhlman, who describe cs phenomena – or in their terminology ‘phenomena of informatics’ – as “occurrences of informatics in everyday life and society” [20] and identify three types of “[...] phenomena of informatics:

1. Phenomena that are directly related to informatics systems. [...]
2. Phenomena that are indirectly linked with informatics systems. [...]
3. Phenomena that are not connected to informatics systems but have an inherent informatical structure or suggest informatical reasoning.“

This structure helps to identify and classify potential phenomena of informatics.

Students come across embedded systems, cyber physical systems and IoT devices (“smart objects”) on a daily basis. What was a vision for Weiser more than 20 years ago, has become reality: “Ubiquitous computing enhances computer use by making many computers available throughout the physical environment, but making them effectively invisible to the user.” [21]. Today, we are frequently confronted with CS phenomena that increasingly often are created by ubiquitous computing devices. Some examples include: home automation, vacuum cleaner or lawn mower robots, self-driving cars, smart watches, IoT devices, digital sign pads, autonomous drones (e.g. Amazon delivery), affective toy pets or robots and art installations.

Clarification of Scientific Content Structure

In order to define the topic areas in which computer science and physical computing overlap, and thus to find relevant contents for physical computing in computer science courses in general education schools that go beyond introductory programming, different approaches were discussed and existing curricula analysed [22]–[25]. The review of earlier research [26], university programs (e.g. [27], [28], [29]), programs by other institutions (e.g. [30]) and textbooks (e.g. [13], [31], [32]) on the wider topic of physical computing has shown many different perspectives (e.g. Makers, Interaction Design, Embedded Systems) from which many contents and contexts relevant for computer science education were extracted that are not yet represented in computer science curricula (e.g. sensing and acting technologies, programming interactive objects, prototyping). In order to highlight key competences in the thematic area of physical computing, the afore-mentioned curricula served as guidelines [7], [33]. Similar to what Schwill [34] described for the software development process and typical informatic thinking and working methods, a typical process of physical computing following the model described by O’Sullivan and Igoe [13] also illustrates typical thinking and working methods of the discipline. Schwill’s work is based on the hypothesis that software development is the core of general education in computer science and is therefore suitable for structuring the school subject of computer science [35]. With the inclusion of physical computing in school curricula, new contents become relevant. It is the aim of physical computing to make computers “...that respond to the rest of your body and the rest of your world” [13] and at the same time operate in the background, ideally unnoticed. Physical Computing embodies the ideal of embedded, ubiquitous hard- and software systems. When working towards this ideal, software development alone is not sufficient. In order to find relevant basic principles or fundamental ideas that can be learnt with physical computing and at the same time to describe the contents of the subject in more detail, it is therefore reasonable and even necessary to look at the development process including aspects of hardware development and design processes. This way, the contents of physical computing can be structured in the context of computer science education.

Investigation of Students’ Perspectives

As suggested both by Kattman et al. and Diethelm et al., the students’ perspective should be pervasive in all planning steps. According to Diethelm et al. [19] central questions in this area are:

1. How do learners experience physical computing phenomena in everyday life and in class?
2. Which phenomena are attractive, accessible and important for whom?
3. Which concepts do students use to explain physical computing phenomena?

Findings from an initial study concerning those questions suggest that we have to face some issues in computer science education: embedded, ubiquitous or interactive computing systems are not in students’ focus, none of the students who took part in the study had any prior in-class-experience with physical computing activities, only few students learn creatively and in constructionist learning environments and students’ project-based interests vary greatly, e.g. depending on their gender [36]. Research data from in-class experiments will give further insights into students’ interests in diverse physical computing phenomena as well as the concepts used to explain certain phenomena before and after a physical computing project was conducted.

Investigation of Teachers’ Perspectives

Another aspect of the CS MER is to include teacher perspectives, particularly focusing on their ideas about teaching and lesson planning in general, students’ conceptions of certain physical computing phenomena and their own conceptions of physical computing phenomena. To integrate teachers into my research from the very beginning, in 2013 I started to provide teacher trainings on physical computing in computer science education. The computer science teachers who participated in those

trainings work in various contexts, such as primary, vocational or high schools. The data collection method to evaluate the professional trainings consisted of three parts. At the beginning of each workshop, all participants were asked about their motivations for participation, their expectations towards the learning objectives and prior experience with physical computing. Then, during the workshops, it was observed how they coped with the challenges and provided materials. After each workshop, the teachers were surveyed either by filling in a feedback questionnaire or in taking part in a semi-structured group interview, to find out about their impressions of the workshop, their ideas for classroom use and what they see as opportunities or barriers towards integrating physical computing into their computer science classes. Later, in early 2015, a large-scale workshop was conducted over two days with teachers from all over Germany who wished to cooperate more closely. Basically, it was intended to provide the participating teachers with the necessary skills to successfully teach physical computing in the context of computer science and to develop teaching materials suitable for their particular needs. Those teachers are now accompanied in their pilot projects and in working closely together with them, their perspectives are analysed.

Analysis of Social Demands

The analysis of social demands is used in this model to ensure the educational significance of the selected phenomena and the corresponding contents. In the context of this research, however, curricula and existing standards will not be decisive, as it is the aim of the thesis to integrate new phenomena and contents of physical computing into CS education. Instead, the social demands are analysed from a societal perspective: How are jobs, everyday life and education affected by embedded and ubiquitous computing systems? Tags such as 'Industry 4.0', 'Internet of Things' or 'Smart Objects' in 'Cyber Physical Systems' and their relevance will be investigated further.

Evaluation: An Iterative Research Design

To evaluate the findings from the educational reconstruction, a network of interested teachers was established. To encourage them to implement pilot projects around certain phenomena, they are provided with the necessary physical computing kits to be used in their pilot projects if, in turn, they report their experiences, give insights into their particular projects and provide research data. Currently, six projects run in parallel, more teachers have announced to start soon. Thanks to the concept of accompanying them in their pilots, the teachers keep contact and are eager to give interviews, let their students fill in questionnaires and even permit classroom visits.

Bibliographic References

- N. Rusk, M. Resnick, R. Berg, and M. Pezalla-Granlund, "New Pathways into Robotics: Strategies for Broadening Participation," *J. Sci. Educ. Technol.*, vol. 17, no. 1, pp. 59–69, 2008.
- G. Stager, "A constructionist approach to robotics," *9th IFIP World Conf. Comput. Educ.* ..., pp. 1–12, 2009.
- S. Libow Martinez and G. Stager, *Invent to Learn: Making, Tinkering, and Engineering in the Classroom*. Torrance, CA: Constructing Modern Knowledge Press., 2013.
- M. Przybylla and R. Romeike, "My Interactive Garden – A Constructionist Approach to Creative Learning with Interactive Installations in Computing Education," in *Constructionism: Theory, Practice and Impact. Proceedings of Constructionism 2012*, 2012, pp. 395–404.
- P. Blikstein, "Gears of Our Childhood: Constructionist Toolkits, Robotics, and Physical Computing, Past and Future," in *Proceedings of the 12th International Conference on Interaction Design and Children*, 2013, pp. 173–182.
- [S. Papert and I. Harel, "Situating Constructionism," in *Constructionism*, S. Papert and I. Harel, Eds. Norwood: Ablex Publishing Corporation, 1991.
- M. Przybylla and R. Romeike, "Key Competences with Physical Computing," in *Proceedings of Key Competencies in Informatics and ICT 2014*, 2014.
- G. Stager, "Outside the Skinner Box. Can Education Technology Make a Course Correction?," *Indep. Sch. Mag.*, vol. 74, no. 2, 2014.
- E. Ackermann, "Piaget's Constructivism, Papert's Constructionism: What's the difference?," *Futur. Learn. Gr. Publ.*, vol. 5, pp. 1–11, 2001.
- [10] Department for Education, *Computing programmes of study: key stages 1 and 2. National curriculum in England*, no. September. England, 2013, pp. 1–2.

- Landesinstitut für Schule und Medien Berlin-Brandenburg, "Teil C Informatik Wahlpflichtfach Jahrgangsstufe 7 – 10 Anhörungsfassung vom 28.11.2014," 2014.
- E. A. Lee and S. A. Seshia, *Introduction to Embedded Systems - A Cyber-Physical Systems Approach*, 1st ed. 2011.
- D. O'Sullivan and T. Igoe, *Physical Computing: Sensing and Controlling the Physical World with Computers*. Boston,: Thomson Course Technology PTR, 2004.
- D. D. Gajski and F. Vahid, "Specification and design of embedded hardware-software systems," *IEEE Des. Test Comput.*, vol. 12, no. 1, pp. 53–67, 1995.
- J. Pardue, *An Arduino Workshop*. Knoxville,: Smiley Micros, 2010.
- J. Teich and C. Haubelt, *Digitale Hardware/Software-Systeme - Synthese und Optimierung*, 2. Auflage. Berlin/Heidelberg: Springer, 2007.
- U. Kattmann, R. Duit, H. Gropengießer, and M. Komorek, "Educational Reconstruction – Bringing together Issues of scientific clarification and students' conceptions," in *Annual Meeting of the National Association of Research in Science Teaching (NARST)*, 1996.
- R. Duit, "Science education research internationally: Conceptions, research methods, domains of research," *Eurasia J. Math. Sci. Technol. Educ.*, vol. 3, no. 1, pp. 3–15, 2007.
- I. Diethelm, P. Hubwieser, and R. Klaus, "Students, teachers and phenomena: educational reconstruction for computer science education," in *Proceedings of the 12th Koli Calling International Conference on Computing Education Research - Koli Calling '12*, 2012, pp. 164–173.
- L. . Humbert and H. . Puhlmann, "Essential ingredients of literacy in informatics," in *8th IFIP World Conference on Computers in Education, WCCE 2005*, 2005.
- M. Weiser, "Some Computer Science Issues in Ubiquitous Computing," *Commun. ACM*, vol. XXXVI, no. 7, pp. 75–84, 1993.
- A. Tucker, F. Deek, J. Jones, D. McCowan, C. Stephenson, and A. Verno, "A Model Curriculum for K–12 Computer Science: Final Report of the ACM K-12 Task Force Curriculum Committee," 2003. [Online]. Available: <http://csta.acm.org/Curriculum/sub/CurrFiles/K-12ModelCurr2ndEd.pdf>.
- Gesellschaft für Informatik (GI) e.V., "Grundsätze und Standards für die Informatik in der Schule," Jan-2008. [Online]. Available: http://www.sn.schule.de/~istandard/docs/bildungsstandards_2008.pdf.
- [24] International Society for Technology in Education (ISTE) and Computer Science Teachers Association (CSTA), "Operational Definition of Computational Thinking," 2011. .
- KMK - Ständige Konferenz der Kultusminister der Länder der Bundesrepublik Deutschland, "Einheitliche Prüfungsanforderungen Informatik," 2004. [Online]. Available: http://www.kmk.org/fileadmin/veroeffentlichungen_beschluesse/1989/1989_12_01-EPA-Informatik.pdf.
- H. Barragán, "Wiring: Prototyping Physical Interaction Design," Interaction Design Institute Ivrea, 2004.
- Interactive Telecommunications Program, "ITP Physical Computing." [Online]. Available: <http://itp.nyu.edu/physcomp/>.
- Royal College of Art, "Design Interactions at the RCA." [Online]. Available: <http://www.design-interactions.rca.ac.uk>.
- Carnegie Mellon University, "Physical Computing." [Online]. Available: <http://www.cmu.edu/ideate/concentrations-and-minors/physical-computing.html>.
- School of Visual Arts, "Curriculum - MFA Program." [Online]. Available: <http://interactiondesign.sva.edu/curriculum>.
- C. Siemers, "Handbuch Embedded Systems Engineering V 0.61a," 2012. [Online]. Available: http://www.in.tu-clausthal.de/uploads/media/Embedded_Systems_Engineering_Handbuch_V0_61a.pdf.
- M. Banzi, *Getting Started with Arduino*, 2nd Editio. Sebastopol, CA: O'Reilly Media / Make, 2011.
- M. Przybylla and R. Romeike, "Physical Computing and its Scope – Towards a Constructionist Computer Science Curriculum with Physical Computing," in *Constructionism and Creativity*, 2014, pp. 278–288.
- A. Schwill, "Fundamentale Ideen der Informatik," *Zentralblatt für Didakt. der Math.*, vol.

25, no. 1, pp. 20–31, 1993.

S. Schubert and A. Schwill, *Didaktik der Informatik*, vol. II. Heidelberg,: Spektrum Akademischer Verlag, 2011.

M. Przybylla and R. Romeike, “Overcoming Issues with Students’ Perceptions of Informatics in Everyday Life and Education with Physical Computing - Suggestions for the Enrichment of Computer Science Classes,” in *ISSEP 2014 - 7th Conference on Informatics in Schools: Situation, Evolution and Perspectives*, 2014, pp. 9–20.

Expectations and motivation to attend the Doctoral Consortium

I attended the Druskininkai DC in 2013 and 2014 and those who know me will see a focus shift in my research design – or possibly finally a focus. After once again rethinking and refocusing my research design, I’m hopeful to receive feedback on my chosen path. I’m particularly thankful for any critical and helpful comments from experienced researchers and doctoral students who work in similar areas and/or with similar methods.

COMPUTATIONAL THINKING: A NEW DIDACTICAL APPROACH FOR TEACHING INTRODUCTORY PROGRAMMING WITHIN THE HUMANITIES

Spangsberg Thomas

1st year of doctoral studies
Department of Digital Design and Information Studies, Aarhus University
Helsingforsgade 14
Aarhus N, 8200, Denmark
tbhs@dac.au.dk

Brief Biography

I hold a MSC-degree in Digital Design from Aarhus University from December 2012. I have been teaching introductory programming- and interaction design courses at the Department of Digital Design and Information Studies since January of 2013 until I started on my Ph.D. project in September 2015.

Teaching programming is considered one of the seven grand challenges of computing education. In my project I will try to formulate an experimentally tested didactical approach to teaching introductory programming within the humanities. Several solutions that could be applied here already exist. They focus on the learning of computational structure through the use of graphical tools, hiding some of the program code or focusing on multimedia manipulation as the main concern for programming. This approach can indeed be useful, but it can also contribute to the notion of act of coding being hard, difficult and inaccessible to non-CS students. In my project will utilize the concepts of computational thinking to completely redesign the course structure and curriculum for an introductory course in programming at Aarhus University's department of Digital Design and Information Studies. The main focus will be on the student's abilities to analyse and solve problems computationally before any code is written. Through a series of experiments designed to highlight different aspects of the teaching, the didactics will be tested and developed iteratively. My main hypothesis will be that if students master the ability to abstract and modulate computational solutions before any code is written, the syntax will be a lesser daring obstacle, then it is at the moment. If this is achieved, this didactical approach will be able to teach students programming without the use of pedagogical tools hiding the program code.

Research area description

Programming is also often viewed by non-CS students as something to get done with quickly, for never to use it again in the rest of their studies [1]. A lot of deeper insights are therefore lost when working with information systems, social media platforms, aesthetic applications etc. When the students lack knowledge about the construction of these systems the valuable knowledge of the underlying possibilities and limitations in such systems are lost. Research done by Bennedsen and Caspersen [2][3][4][5] tries to uncover what abilities are a key to successful learning programming. This research was carried out on CS students. A correlation between the amount of course work done by the student and the learning ability seems to be quite significant [3]. The notion of course work as an indicator is supported by general contemporary learning theory, as an emphasis on student's active involvement and exploratory and collective learning [11]. There are multiple approaches to doing this: Earlier approaches concentrated on teaching programming on a semiotic basis, like learning a new language [17][1][16]. Jerinic [16] proposes a method of learning through mistakes. Here, Students for example have to correct errors in code, deliberately made by the teacher or are asked to solve a task resulting in a faulty behaviour of the code and then find the correct solution to this. Examples of this high involvement of students are found in techniques like *live programming* and *blackboard programming* where the students and the teacher in plenum solve a certain programmatic task [2].

The main theme of the project will be computational thinking - *CT*. *CT* was popularized [10] in 2006 by Wing [20]. It is a set of competences that help our abilities to solve complex problems derived from the field of computer science including abstraction, algorithmic thinking, logical thinking and modulation [21] As studies have already been made, suggesting the use of computational thinking for non-CS students [18][19], the students will be required to analyse their assignments by using computational thinking before any coding is written. The students will be working with raw data available from the Open & Agile Smart Cities - OASC initiative [22] to create a dynamic web page. Other teaching approaches seem to

focus on multimedia [12][13][14][15] and/or non-conventional/graphical programming [6][7][9][15] as the main tool of teaching. In this course, no special tools/applications for teaching programming will be used, other than a standard simple developer's IDE. By doing so, I hope to optimize students intrinsic load [8] and to focus the experiment on the benefits of explicitly employing a computational thinking approach to the course. Even though no special tools will be used, this experiment may help provide some insights for use in developing future teaching tools aimed at non-CS students. Also, as open data becomes ever more available and software systems ever more embedded in our everyday life, this teaching may open up the mysteries of programming to a much broader audience.

The main contribution I hope to give to the field is a suggestion to how “real” programming can be taught to students within the humanities, so that the skills they master will not fade away after the course ends. It is my hope that the students will experience coding as a trade not reserved to just software engineers and professional developers. Most importantly I will try to do this without the use of special software teaching-tools and with the use of real data for the students to work on and manipulate. A further outcome of this could be that more people would be able to participate in the development of open software and -data – A further opening up of open source and -data.

A presentation of any preliminary ideas, the proposed approach and achieved results

At the moment of writing, I am in the process of preparing the first of my empirical experiments of teaching. I will teach an introductory programming course from the 23rd of November until the 18th of December 2015. It is a condensed type of course run over four weeks:

- Week I (three days): Introduction to web pages - both static and dynamic and basic interaction design (HCI)
- Week II (three days): JAVA crash course
- Week III (three days): Experience build-up and routine through exercises.
- Week IV (five days): Completion of a larger mandatory project. □□

Regarding week III: During this week, I will be at the DC. Therefor the students will be doing exercises the whole week under supervision of a teaching assistant - TA. The TA will also be supervising all of the other exercise-classes during the course.

This course will serve as the preliminary experiment in my research. It will be followed by at least two more courses, which I will teach during my enrolment as a Ph.D. Fellow. Apart from doing the experiments my self I will also conduct a series of qualitative research interviews with other lecturers teaching programming, both at my home university and abroad. By doing so I hope to establish a catalogue of current best practice within the field and what benefits can be made hereof. This will be put to use during the exploratory experiments throughout as my project progresses. During the whole project period, it is my plan to regularly publish various materials on my research: Posters, work in progress papers, short papers and regular papers as part of my dissertation, which will be a portfolio of my published work. My results will mainly be based on surveys among the students I teach, which I will use to continuously improve and iterate my teaching didactics. I will also count in the student's final results in the course as a parameter for assessing the effectiveness of my teaching. Coupled with the feed back and review I receive on my publications I hope in the end to be able to conduct a final experiment validating my didactical approach. In the very end it is my goal to condense my experimental work down to a set of recommended guidelines and examples of the most effective methods and didactics for teaching non-CS students programming.

Bibliographic References

1. Andersen, P. B, Bennedsen, J., Brandorff, S., Caspersen, M. E. & Mosegaard, J.: Teaching Programming to Liberal Arts Students - A Narrative Media Approach. ITICSE'03, 2003.
2. Benndsen, J. & Caspersen, M. E. Revealing the Programming Process. Proceedings of the 36th SIGCSE Technical Symposium on Computer Science Education, SIGCSE 2005, pp. 186-190. 2005a.
3. Bennedsen, J. & Caspersen, M. E. An investigation of potential success factors for an introductory model-driven programming course. In: Proceedings of the first international workshop on Computing education research (ICER '05). ACM, pp. 155-163. 2005b.

4. Bennedsen, J. & Caspersen, M. E. Abstraction Ability as an Indicator of Success for Learning Object-Oriented Programming? SIGCSE Bulletin (Association for Computing Machinery, Special Interest Group on Computer Science Education), 38(2), pp. 39 – 43. 2006.
5. Bennedsen, J. & Caspersen, M. E. Abstraction Ability as an Indicator of Success for Learning Computer Science? Proceedings of the 4th International Computing Education Research Workshop (ICER'08), ACM, pp. 15-26. 2008.
6. Brynskov, M. Lundning, R. and Vestergaard, L. S. DUL Radio: A light-weight, wireless toolkit for sketching in hardware. Tangible and Embedded Interaction Work-in-Progress Workshop Proceedings, 2011.
7. Chang, C.-K. Effects of Using Alice and Scratch in an Introductory Programming Course for Corrective Instruction. Journal of Educational Computing Research, Vol. 51 Issue 2, 2014.
8. Clark, R. C., Nguyen, F. and Sweller, J. Efficiency in Learning: Evidence-Based Guidelines to Manage Cognitive Load. John Wiley & Sons, 2011.
9. Cortina, T. J. An Introduction to Computer Science for Non-majors Using Principles of Computation. SIGCSE'07, 2007.
10. Curzon, P. Unplugged computational thinking for fun. Proceedings of Key Competences in Informatics and ICT (KEYCIT 2014). 2014
11. Gogoulou, A., Gouli, E. & Grigoriadou, M. Teaching Programming with ECLiP Didactical Approach. Proceedings of the IADIS International Conference 09. pp. 204-211. 2009
12. Guzdial, M. A Media Computation Course for Non-Majors. ITiCSE'03, 2003.
13. Guzdial, M. Exploring Hypotheses about Media Computation. ICER'13, 2013.
14. Guzdial, M. and Forte, A. Design Process for a Non-majors COmputing Course. SIGCSE'05, 2005.
15. Guzdial, M. and Soloway, E. Teaching the Nintendo Generation to Program. Communication of the ACM, 2002.
16. Jerinic, L. Pedagogical Patterns For Learning Programming By Mistakes. Conference: Computer Algebra and Dynamic Geometry Systems in Mathematical Education 2012, CADGME 2012
17. Kaasbøll, J. J. Exploring Didactic Models for Programming. In Proceedings of the Norsk Informatikk-Konferanse. Høgskolen I Agder. pp. 195-203. 1998
18. Li, T. and Wang, T. A Unified Approach to Teach Computational Thinking for First Year Non-CS Majors in an Introductory Course. IERI Procedia 2, 2012.
19. Rode, J. A., Weibert, A., Marshall, A., Aal, K., von Rekowski, T., el Mimoni, H. and Booker, J. From Computational Thinking to Computational Making. UbiComp'15, 2015.
20. Wing, J. M. Computational Thinking, Communications of the ACM, viewpoint, vol. 49, no.3 March, 2006.
21. Wing, J. M.: Computational thinking and thinking about computing, Philosophical Transactions of the Royal Society A, no. 366, 2008.
22. <http://connectedsmartcities.eu/open-and-agile-smart-cities/>, (last seen October 22nd 2015).

Expectations and motivation to attend Doctoral Consortium

My co-supervisor: Michael Caspersen, pointed me towards this doctoral consortium. After having reviewed the agenda and doing more reading on the website, I found it very relevant for me to participate. Especially while I am still in the beginning of my project period. I am very much interested in getting new insights on how I can structure my teaching experiments in the future of my project. I am specifically interested in the methodology for doing this, as this is still a new role for me to do research within this field. I also hope to get some feedback on how I can use the insights I already have from my current experiment, which is already being conducted while I am at the doctoral consortium. So I will already have with me some partial results of the first experiment. I would also very much like to receive some qualified and critical feedback on my preliminary findings and analysis. Lastly, this will be my first international event and I am looking very much forward to receive and read the works of my fellow Ph.D. students and meeting them in person.

MODELLING OF INFORMATICS CONCEPTS THROUGH INTERACTIVE TASKS

Stupurienė Gabrielė

Second year PhD student
Vilnius University Institute of Mathematics and Informatics
Akademijos str. 4, Vilnius, Lithuania
gabriele.stupuriene@mii.vu.lt

Short biography

She has developed and defended her master thesis “Conceptualization of Informatics Fundamentals through Tasks” in 2011 in Vilnius University Faculty of Mathematics and Informatics.

Interests: Computational thinking, Informatics (computer science) concepts, Constructionist and deconstructionist approach.

Publications:

1. Dagienė, V., Mannila, L., Poranen, T., Rolandsson, L., **Stupurienė, G.** Reasoning on children's cognitive skills in an informatics contest: findings and discoveries from Finland, Lithuania, and Sweden. ISSEP 2014, Istanbul, Turkey, September 22-25, 2014: proceedings /editors: Gülbahar, Yasemin, Karataş, Erinç. - Book series: Lecture notes in computer science, Vol. 8730. ISSN 0302-974, 66-77.
2. Dagienė, V., Pėlikis, E., **Stupurienė, G.** Introducing computational thinking through a contest on informatics: problem-solving and gender issues, 2015, 73, p. 55-63.
3. Dagienė, V., **Stupurienė, G.** Informatics education based on solving attractive tasks through a contest. KEYCIT 2014 - Key Competencies in Informatics and ICT: (Preliminary Proceedings), July 1st-4th, 2014, University of Potsdam, Germany, 2014, 51-62.
4. **Stupurienė, G.**, Jasutė, E. Finding threshold concepts in computer science contest. IFIP TC3 working conference “A new culture of learning: computing and next generations”: preliminary proceedings, 2015, p. 289-293.
5. Barendsen, E. Mannila, L., Demo, B., Grgurina, N., Izu, C., Mirolo, C., Sentance, S., Settle, A., **Stupurienė, G.** Key Concepts in K–9 Computer Science Education, ITiCSE '15 Proceedings of the 2015 conference on Innovation & technology in computer science education, ACM Digital Library (under reviewing process), 2015.
6. Dagienė, V., Pėlikis, E., **Stupurienė, G.** Informatinio mąstymo ugdymo užduotys: merginų ir vaikinų sprendimų analizė. Acta Paedagogica Vilnensia, Vol. 35, 2015.
7. Dagienė, V., Sutkutė, E., **Stupurienė, G.** Informatikos konkurso grafų uždavinių analizė, Informacijos mokslai, Vol. 73, 2015.

Research area description

Concepts of informatics play a central role in all curricula and standards for informatics education at secondary schools. In practice at schools however very often the training of skills in application software is given much more room than the understanding of fundamental concepts of informatics. The curricula of informatics education must be not overload of notions and concepts that pupils must know and understand.

The international Bebras challenge on informatics and computational thinking has the goal to convey informatics concepts to as many school students as possible in a way that can motivate them to be more interested in informatics. The main goals of the Bebras challenge are to promote pupils interest in informatics from the very beginning of school and lead them to develop computational thinking abilities. Actually, the idea was to involve pupils into informatics task solving activities and to use computational thinking and modern technologies more intensively and creatively (Dagiene, Futschek, 2013).

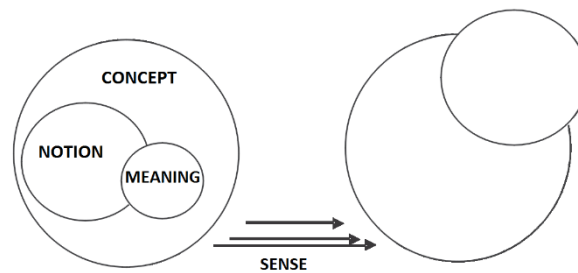

Figure 1. MEANING – NOTION – CONCEPT AND SENSE (Gudavičius, 2011)

Informatics concepts have relation with the concept-based pedagogical approach to school informatics (Hadjerrouit, 2009). The Bebras challenge tasks can be used in the first phase (every task have informatics problem inside).

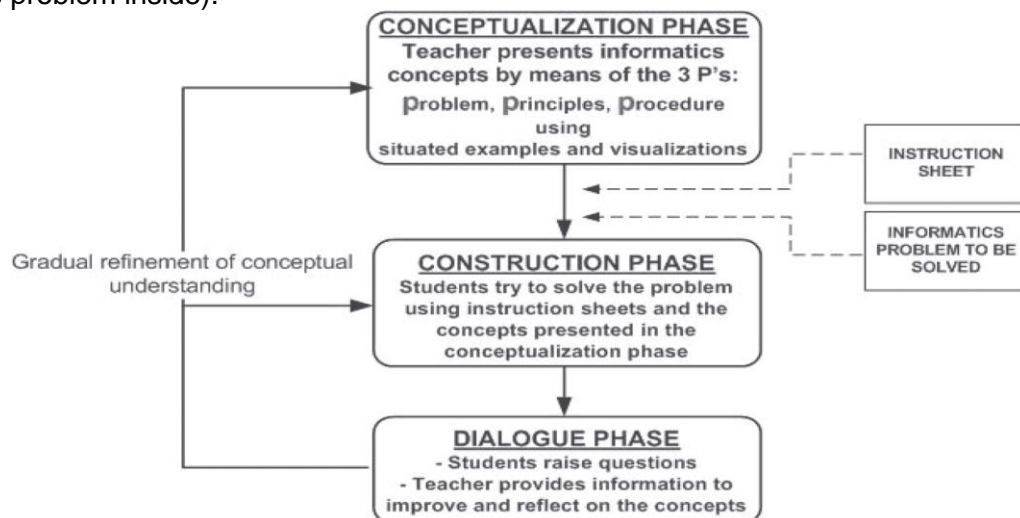

Figure 2. Three phases of concept-based pedagogical approach (Hadjerrouit, 2009)

- **The aim of research** - to create recommendation lists of the fundamental informatics concepts according to pupils' age groups, to create recommendation system for searching learning objects (Bebras tasks) related with fundamental informatics concepts (preliminary), to prepare methodology of interactive tasks development (preliminary).
- **An outline of the current knowledge of the problem domain** - in the scientific literature the informatics concepts are classified in:
 1. (Fundamental/key/main/central/core) informatics concepts;
 2. Computational thinking concepts;
 3. Programming concepts;
 4. Threshold concepts.

If core concepts are the building blocks of knowledge, then threshold concepts can operate to transform and integrate that knowledge into a new way of thinking (Barradell, Peseta, 2014).

Threshold Concepts can be as a possible way to organize and focus learning in computer science. Meyer and Land (Boustedt, et al., 2007) define threshold concepts:

1. **Transformative**: they change the way a student looks at things in the discipline.
2. **Integrative**: they tie together concepts in ways that were previously unknown to the student.
3. **Irreversible**: they are difficult for the student to unlearn.
4. **Potentially troublesome for students**: they are conceptually difficult, alien, and/or counter-intuitive.
5. **Often boundary markers**: they indicate the limits of a conceptual area or the discipline itself.

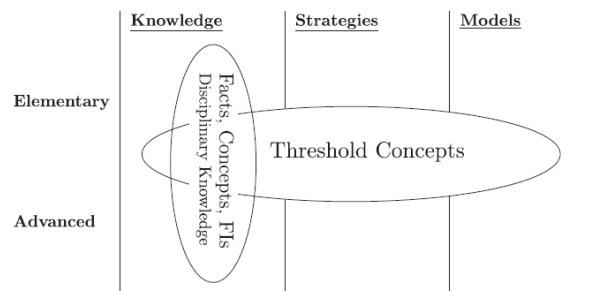

Figure 3. Fundamental ideas and threshold concepts (Rountree, et al., 2013)

Computational thinking (CT) is a problem-solving process that includes (but is not limited to) the following characteristics (CSTA and ISTE, 2011):

- Formulating problems in a way that enables us to use a computer and other tools to help solve them;
- Logically organizing and analyzing data;
- Representing data through abstractions such as models and simulations;
- Automating solutions through algorithmic thinking (a series of ordered steps);
- Identifying, analyzing, and implementing possible solutions with the goal of achieving the most efficient and effective combination of steps and resources;
- Generalizing and transferring this problem solving process to a wide variety of problems.

Computational thinking, a term meant to encompass a set of concepts and thought processes that aid in formulating problems and their solutions in different fields in a way that could involve computers.

Definition by CSTA and ISTE of CT suitable for use in K-12 education, identifying nine essential categories:

- data collection,
- data analysis,
- data representation,
- problem decomposition,
- abstraction,
- algorithms,
- automation,
- parallelization
- simulation.

Figure 4. Nine categories of computational thinking (CSTA and ISTE, 2011)

A presentation of any preliminary ideas, the proposed approach and achieved results

After conceptual content analysis of educational documents (National Core Curricula (Lithuania) (2011), K–12 Computer Science Standards (ISTE, 2011), UK curriculum for school (Computing at School, 2012), Computing progression pathways (Computing at School, 2014)) for informatics education experts was offered questionnaire with 135 informatics concepts for school education. In the questionnaire concepts distributed into nine categories of computational thinking (these categories taken from CT definition). Some of concepts was in „Other“ category (if it not suitable for computational thinking). Experts use Likert scale for choosing if concepts is suitable for pupils.

Table 1. The result of primary survey (number of informatics concepts for pupils)

| Age 11-16 | Age 16+ |
|-----------|---------|
| 55 | 119 |

- **The next steps (preliminary):**
 - To find the way (theory) how to formalize the area of informatics concepts.

- To create classifications or ontology of informatics concepts.
- To read more about the recommendation systems. How it can be used in this area.
- To create model of recommendation systems related with informatics.
- To prepare methodology of interactive tasks development (maybe).
- To perform expert assessment of model.

Bibliographic References

1. A Curriculum for School. (2012). Computing At School. Retrieved from <http://www.computingatschool.org.uk/data/uploads/ComputingCurric.pdf>
2. Barr, V., Stephenson, C. (2011). Bringing Computational Thinking to K-12: What is Involved and What is the Role of the Computer Science Education Community? *Inroads*, Vol. 2(1).
3. Barradell, S., Peseta, T. (2014). Promise and challenge of identifying threshold concepts: a cautionary account of using transactional curriculum inquiry. *Journal of Further and Higher Education*. DOI:10.1080/0309877X.2014.971105.
4. Boustedt, J. Eckerdal, A., McCartney, R., Moström, J.E., Ratcliffe, M., Sanders, K., Zander, C. (2007). Threshold concepts in computer science: do they exist and are they useful? *ACM SIGCSE Bulletin*, 39(1), 504-508.
5. Dagiene, V., Futschek, G. (2013). Bebras, a contest to motivate students to study computer science and develop computational thinking. In: Proceedings of WCCE 2013: Learning while we are connected, 139-141.
6. Gudavičius, A. (2011). Reikšmė – sąvoka – konceptas ir prasmė (Lithuanian). *Res Humanitariae*. Vol. 10 Issue 2, p108-119.
7. Hadjerrouit, S. (2009). Teaching and Learning School Informatics: A Concept-Based Pedagogical Approach. *Informatics in Education*, 8(2), 227-250.
8. Lee, I., Martin, F., Apone, K. Integrating computational thinking across the k-8 curriculum. *ACM Inroads*, 5(4):64-71, December, 2014.
9. Mannila, L., Dagiene, V., Demo, B., Grgurina, N., Mirolo, C., Rolandsson, L., Settle, A. Computational thinking in K-9 education. In: Goldweber, M. (ed.): ITiCSE '14 Proceedings of the 2014 conference on Innovation & technology in computer science education. p. 1-29, 2014.
10. Meyer J. H. F. and Land R., 2003 'Threshold Concepts and Troublesome Knowledge – Linkages to Ways of Thinking and Practising' in Improving Student Learning – Ten Years On. C. Rust (Ed), OCSLD, Oxford.
11. Mittermeir, R., Bischof, E., Hodnigg, K. Showing core-concepts of informatics to kids and their teachers. In ISSEP 2010, volume 5941 of LNCS, pages 143-154. Springer, 2010.
12. Rountree, J., Robins, A. and Rountree, N. (2013) Elaborating on threshold concepts. *Computer Science Education*, Vol. 23, Issue 3, p. 265-289.
13. Selby, C., How Can the Teaching of Programming Be Used to Enhance Computational Thinking Skills? 2014, doctoral dissertation.
14. Szlávi, Péter; Zsakó, László. Key Concepts in Informatics: Algorithm. *Acta Didactica Napocensia*; 2014, Vol. 7 Issue 1, p. 39.
15. Tucker, A., McCowan, D., Deek, F., Stephenson, C., Jones, J., & Verno, A. (2003, 2006). A Model Curriculum for K–12 Computer Science: Report of the ACM K–12 Task Force Computer Science Curriculum Committee, New York, NY: Association for Computing Machinery.
16. Zandler, A., Spannagel, C. (2008). Empirical Foundation of Central Concepts for Computer Science Education. *ACM Journal on Educational Resources in Computing*, 8(2).
17. Wing, J. M. (2006). Computational thinking. *Communications of the ACM*, 49(3), p. 33-35.

Expectations and motivation to attend Doctoral Consortium

I would like to get answers to some questions:

1. How to formalize the area of fundamental informatics concepts? (At the moment it is not formalized)
2. What other theories to use?
3. To pay more attention to teachers or to students?

MODELLING OF MANAGEMENT DECISIONS' PROCESSES IN SPECIALISTS' TRAINING SYSTEM ITLE

Tkachenko Kostiantyn

Kyiv National university of Culture and Arts
"VU-DC-2015 <Tkachenko>"
Kyiv, Gorkogo str. 124-128, 03150, Ukraine
tkachenko.kostyantyn@gmail.com

My Brief Biography

Research area description

As part of theme «Modelling of management decisions' processes in specialists' training system» explores some aspects of the STS' modelling, in particular:

- the structure of the system; its main components, conditions, processes;
- model of the future specialist, domain model preparation, model, teacher, model of communication system components, its objects and subjects;
- the relationship between the models;
- classification of management decisions);
- routing management decision-making processes;
- situational decision-making;
- information technology to support decision-making.

Modeling of processes of management decision-making is carried out based on the proposed author situation-production model that takes into account a wide range of local and global impacts, including the state of the labor market and the education market. Making decisions based on the proposed situation-production model comes with the appropriate information technology.

Publications:

1. К.О.Ткаченко, О.І.Ткаченко Ситуаційно-продукційне моделювання системи підготовки фахівців водного транспорту // Системний аналіз. – 2012. – Вип. 11. – Частина 4. – С. 170 - 174.
2. К.О.Ткаченко, О.І.Ткаченко Моделювання системи підготовки/перепідготовки фахівців водного транспорту//IX міжнародна конференція «Нові інформаційні технології в освіті для всіх» ІТЕА-2014. (Київ, 26 листопада 2014). К. – 2014. – Ч.2. – С.237-242.
3. К.О.Ткаченко, О.І.Ткаченко, О.А.Ткаченко Моделювання системи підготовки фахівців водного транспорту на основі мереж Петрі //Водний транспорт. – 2015. – Вип. 21.
4. К.О. Ткаченко, О.І. Ткаченко Деякі аспекти багаторівневого моделювання складної економічної системи підготовки фахівців //Вісник Одеського Національного університету. Економіка. Том.20. вип.3. Одеса: ОНУ. – 2015.

The need for a conceptual model of the specialists' training system (STS) justify the current requirements for managerial decisions making in the field of specialists' training, analysis of the various aspects of the STS management and modeling of appropriate managerial decisions making.

Existing approaches to modeling of complex economic systems which include STS led to the urgency of the managerial decision making problems on the basis of modeling processes which take place in the STS.

Theoretical bases of modeling systems have been presented in the works of the following scientists: E. Gamma, R. Khelm, R. Dzhonson, Dzh. Vlissides, A.A. Vavilov, A.A.Petrov, I.G. Pospelov, D.A. Pospelov, A.A. Shanenin, P.S. Krasnoshchokov, I.A. Krass, I.V. Levandovskaya, I.S. Dmitrenko, O.N. Kuznetsova, Dzh. Subotski, G.Mintsberg, F.S.Roberts.

Modeling of STS provides presence of the following classification of management objectives, organization and functioning of the STS:

- Conceptual (conceptual understanding, organization, anticipation and integration of all other classes).

- Fundamental (modeling of fundamental objects of the STS, considering the internal and external situations (local and global).
- Specialized (modeling of processes of individual objects and subjects of the STS).

Development of the STS provides for its analysis and development of technology on the basis of the system's model. General requirements for such models are: the adequacy; objectivity; simplicity; agility; reliability; resistance; versatility; completion.

As a model of the STS in this paper the situation-production model (SPM), which satisfies the above mentioned requirements. To build this model, you need to determine: goals of STS simulation; the main classes of STS problems; criteria for STS model evaluation; criteria for evaluating the STS; classes of STS impact factors (local and global, internal and external); classes of situations that arise in the STS.

The paper deals with making of managerial decisions based on the SPM in order to determine:

- the number of enterprises STS, their level and specialization based on their integrated rating;
- the number of people who receive educational services;
- the volume and range of issued educational services.

In order to make management decisions on the basis of SPM of STS, the following steps should be clarified: who makes the decisions; what are the objectives of decision-making; what is the decision-making; what is a set of possible options to achieve the objective; the conditions under which decisions are made.

SPM of STS is a dynamic model. It takes into account the possibility of appearing of a new kind of educational services, new factors of impact or increasing of the time interval. In such situations model changes its shape and provides the possibility to take into account the new data for making the better prediction.

The model, on the basis of which the managerial decisions take place, should take into account the set of conditions and impact factors, at which decisions are made. Such opportunity is provided by the SPM of STS, specifying elements of which, defining their characteristics and properties, you can get the specific decision-making model by taking into account the situation, impact factors, decision-maker (his goals in the reviewed STS situation), STS issues.

SPM considers the influencing factors (external, internal, intra, inside the enterprise) of the STS. STS^{OMO}_{gener} – Common organization's SPM, management and operation of the STS – have the following appearance:

$$STS^{OMO}_{gener} = STS^{OMO}_{ext} \cup STS^{OMO}_{int} \cup STS^{OMO}_{intra} \cup STS^{OMO}_{inside},$$

where the following impact factors' models are used:

STS^{OMO}_{ext} – external,

STS^{OMO}_{int} – internal;

STS^{OMO}_{intra} – intra industrial,

STS^{OMO}_{inside} – inside the STS enterprise. Considering these groups of factors, the STS model will look like:

$$STS^{OMO} = STS^{OMO}_{sds} \cup STS^{OMO}_{gsds} \cup STS^{OMO}_{sdes} \cup STS^{OMO}_{gsdes} \cup STS^{OMO}_{ms} \cup STS^{OMO}_{pp} \cup STS^{OMO}_{gpp} \cup STS^{OMO}_{cc} \cup STS^{OMO}_{qoi} \cup STS^{OMO}_{da} \cup STS^{OMO}_{bs}$$

Where the following submodels are used:

STS^{OMO}_{sds} (STS^{OMO}_{gsds}) – supply / demand (growth in supply / demand) of specialists in all labor markets;

STS^{OMO}_{sdes} (STS^{OMO}_{gsdes}) – supply / demand (growth in demand / supply) of educational services;

STS^{OMO}_{ms} (STS^{OMO}_{pp}) – monetary sphere (public price) for the development and functioning of the STS;

STS^{OMO}_{gpp} – government policies of price regulation for educational services;

STS^{OMO}_{cc} – competition and the competitiveness of STS educational services and enterprises;

STS^{OMO}_{qoi} – quality, originality and innovation of educational services;

STS^{OMO}_{da} – dynamism and the adequacy of the STS to the current requirements;

STS^{OMO}_{bs} – dynamicity of enterprises' basic supplying with the STS.

Each submodel of the STS has the following form: **STS^{OMO} = {<S^{OMO}, P^{OMO}>}**,

where **<S^{OMO}, P^{OMO}>** – products (principle) that displays the conversion of ATP (change, development, regression, stability);

S^{OMO} – set of situations that arise in the STS;

P^{OMO} – a variety of activities that define the STS processes (organization, management, operation and training).

STS modeling envisages the development the specialist model. When forming the specialist model you should take into account the fact that the competitiveness of the specialist may be determined by the level of his professionalism. The specialist's requirements after completing preparatory processes should take into account, in particular, the supply / demand in the labor market, the level of the right experts and their specialization. Specialist's model displays the volume and structure of its professional and socio-psychological characteristics, knowledge and skills, types of training, curricula and programs. When you create a specialist's model, the following requirements should be met:

- specialist's model should be different for the young specialists and experienced professionals.
- Models of professionals who have the same profession, but different specializations may differ from each other.

Administrative decisions on the STS development are focused on the development of the STS, strengthening links with the labor market and educational services, achieving the appropriate level of social usefulness of STS; ensuring the Ukraine's STS entrance into the European and world educational space on the principle of specialists' transferring, technologies, and educational services; the implementation of new forms and methods of educational services (eg, E-education); the increase of educational services' volume; increasing the competitiveness level of Ukrainian STS enterprises; improving the quality of educational services.

Automating of the decision-making process based on the SPM is carried out by means of an appropriate managerial decision making supporting system by determination: range and volume of educational services, the number of STS enterprises and their specialization based on their integral indicator rating.

ASSESSMENT IN COMPUTER SCIENCE EDUCATION UNDER PRESSURE⁵

Vegt Willem van der

Waiting for a grant; second year of preparation
 Windesheim University for Applied Sciences
 PO Box 10090
 8000 GB Zwolle The Netherlands
 w.van.der.vegt@windesheim.nl

Your Brief Biography

Since 1984 I am a teachers trainer for mathematics and computer science at Windesheim University for Applied Sciences. I was organizing in-service training for high school teachers to prepare them for teaching computer science and to provide them with a formal teaching degree (CODI-project, 1998-2005).

Since 1991 I am involved in the Dutch and the International olympiad in Informatics and since 2005 in the Bebras contest.

Publications:

Vegt, W. van der (2009). Using Subtasks, in *Olympiads in Informatics, Vol. 3*, pp. 144-148.

Pohl, W., Burton, B.A., Dagiene, V., Skupas, B., Fakcharoenpol, J., Forisek, M., Hiron, M., Opmanis, M. en Vegt, W. van der (2010). Get Involved! The IOI Workshop 2010, Its Goals and Results. In *Olympiads in Informatics, Vol. 4*, pp. 158-169.

Vegt, W. van der (2012). Theoretical Tasks on Algorithms; two Small Examples. In *Olympiads in Informatics, Vol. 6*, pp. 212-217.

Vegt, W. van der (2013). Predicting the Difficulty Level of a Bebras Task. In *Olympiads in Informatics, Vol. 7*, pp. 132-139.

Research area description

Introduction

In the Netherlands computer science is a non mandatory subject in secondary education. There is no national exam, like for other subjects such as mathematics and geography; schools have to organize their own assessments, based on the goals of the national curriculum.

Computer science education has two faces: It is about designing and building working programs and information systems as well as about understanding the fundamental concepts of information processing. In the schools the emphasis is mainly on the first aspect [19, 23]. Practical exercises are often used and in assessments the focus is on the development process. Also in other countries teachers have problems with assessment of concepts [26].

Theoretical background

Summative assessment is used to evaluate the learning outcome of education. A test matrix [1] can be used to check if the test fits the intended learning goals. On the one axis these goals are displayed, on the other axis the levels of mastering (see for instance [10]). These levels of mastering can be characterized using a taxonomy [5]. For computer science education the SOLO-taxonomy [4] gives a promising refinement for characterizing conceptual assessment in a development context [15].

A surprising and informal source of conceptual assessments are competitions like the international Bebras Challenge [3]. Knowledge of concepts of computer science, like algorithms, informations and structures, is tested using compact, well designed so called tasklets or minitature tasks. [7, 24].

⁵ The Dutch title of my research proposal has a pun that is hard to translate. "Informatica: druk op de toets" means "Computer science: assessment under pressure", but could also be interpreted as "Computer science: press the button", which of course resembles a common misunderstanding about computer science education.

The content-specific didactical knowledge of teachers is called the Pedagogical Content Knowledge (PCK). This knowledge represents “the blending of content and pedagogy into an understanding of how particular topics, problems, or issues are organized, represented, and adapted to the diverse interests and abilities of learners and presented for instruction” [20, p. 8]. Magnusson, Krajcik and Borko [14] distinguish four PCK-elements with regards to a specific topic: knowledge on (1) educational goals, (2) understanding and confusion by pupils, (3) instructional strategies and (4) forms of assessment. These PCK-elements somewhat depend on each other, but in our research we will focus mainly on element (4) for teachers of computer science.

There has been a lot of research on PCK since the 1980s and on the development of PCK by teachers, but mainly in science (for instance [2, 9, 25]). PCK-research on computer science education is scarce [12, 18].

Research question

How can assessment of fundamental concepts of computer science be designed and which knowledge do computer sciences teachers need to have the ability to realize this assessment?

We will handle this question using three subquestions:

1. How can the current practice in the school exams for computer science be described in relation to the goals of the national curriculum? How can the pedagogical content knowledge on specific concepts be described (specially the fourth PCK-element, knowledge of assessment)?
2. What are suitable forms and instruments for testing concepts of computer science?
3. Which knowledge do teachers need to be able to apply these testing forms and instruments successfully?

Contribution to scientific development

The proposed research will contribute to knowledge about assessment of concepts, especially in context-rich learning environments. It will extend the research of PCK and PCK-development to computer science education. The focus on PCK-element (4) is new.

A presentation of any preliminary ideas, the proposed approach and achieved results

The most important part of the research will be done in the form of design research. In an iterative cyclic process will be worked on the development of forms, instruments and materials for testing. This will be done in a professional learning community [6] with ten computer science teachers, to investigate the needed PCK-development of teachers.

We will start analyzing the current assessment practice (subquestion 1). We will use data from the PLC-teachers, but also assessment plans and exam exercises that are available on the online community for computer science teachers.

For the development of tests (subquestion 2), we will work with the renewed curriculum for computer science [21], existing frames for competences (for instance [16, 22]) and taxonomies like SOLO.

International databases with questions and results of the Bebras Challenge are available to analyze conceptual content, question formulation and competence levels. The validity of the developed instruments will be determined using proven quantitative and qualitative techniques like concept mapping [17] and learner reports (in the enriched style according to [8]).

To research and follow the PCK of teachers (subquestions 1 and 3) we will use known research instruments for PCK like interviews in the *Content Representation* format [13], stimulated recall interviews, and the discussions in the PLC as a ‘focusgroup’. So we will collect a collection of data about teachers in many dimensions, to be able to perform triangulations. The construction PCK is way too complex to be able to catch it with one instrument [11].

Bibliographic References

1. Berkel, H. van & Bax, A. (Red.) (2006). *Handboek: Toetsen in het hoger onderwijs*. Houten. Bohn, Stafleu van Loghum.
2. Berry, A., Friedrichsen, P. & Loughran, J. (Eds.) (2015), *Re-examining pedagogical content knowledge in science education*. Routledge.
3. Bebras Challenge (2015). <http://www.bebbras.org> (visited 2015 November 15th).
4. Biggs, J. B. & Collis, K. (1982) *Evaluating the Quality of Learning: the SOLO taxonomy*. New York, Academic Press.
5. Bloom, B. S.; Engelhart, M. D.; Furst, E. J.; Hill, W. H. & Krathwohl, D. R. (1956). *Taxonomy of educational objectives: The classification of educational goals. Handbook I: Cognitive domain*. New York: David McKay Company.
6. Coenders, F. (2010). *Teachers' professional growth during the development and class enactment of context-based chemistry student learning material*. Unpublished doctoral dissertation, University of Twente, The Netherlands.
7. Dagiène, V. & Futček, G. (2008). Bebras international contest on informatics and computer literacy: criteria for good tasks. In: Mittermeier, R.T., Syslo, M.M. (Eds.), *ISSEP 2008, LNCS 5090*, pp. 19–30, Springer-Verlag Berlin Heidelberg.
8. Groot, A.D. de (1980). Learner reports as a tool in the evaluation of psychotherapy. *Psychotherapy: Research and Training*. Elsevier/North-Holland Biomedical Press, pp. 177-182.
9. Henze, I., Van Driel, J. H. & Verloop, N. (2008). Development of experienced science teachers' pedagogical content knowledge of models of the solar system and the universe. *International Journal of Science Education*, 30(10), 1321–1342.
10. Kadujevic, D.M., Angeli, Ch. & Schulte, C. (2013). *Improving Computer Science Education*. Routledge.
11. Kagan, D. M. (1990). Ways of evaluating teacher cognition: Inferences concerning the Goldilocks principle. *Review of educational research*, 60(3), 419–469.
12. Koppelman, H. (2008). Pedagogical Content Knowledge and Educational Cases in Computer Science: An Exploration. *Proceedings of the Informing Science & IT Education Conference (Iⁿ SITE)*.
13. Loughran, J., Mulhall, P., & Berry, A. (2004). In search of pedagogical content knowledge in science: Developing ways of articulating and documenting professional practice. *Journal of Research in Science Teaching*, 41(4), 370–391. □
14. Magnusson, S., Krajcik, J., & Borko, H. (1999). Nature, sources and development of pedagogical content knowledge for science teaching. In J. Gess-Newsome & N. G. Lederman (Eds.), *Examining pedagogical content knowledge: The construct and its implications for science education* (pp. 95-132). Dordrecht, The Netherlands: Kluwer Academic.
15. Meerbaum-Salant, O., Armoni, M. & Ben-Ari, M. (2013). Learning computer science concepts with Scratch. *Computer Science Education*, 23:3, 239-264.
16. Neugebauer, J., Hubwieser, P., Magenheimer, J., Ohrndorf, L., Schaper, N. & Schubert, S. (2014). Measuring Student Competences in German Upper Secondary Computer Science Education. In: Gülbahar, Y. en Karataş, E. *ISSEP 2014, LNCS 8730*, pp. 100-111. Springer International Publishing Switzerland.
17. Novak, J.D. & Cañas, A.J. (2006). *The Theory Underlying Concept Maps and How to Construct and Use Them*. Technical Report IHMC CmapTools 2006-01 Rev 2008-01.
18. Saeli, M. (2012). *Teaching programming for Secondary School: a Pedagogical Content Knowledge Based Approach*. Technische Universiteit Eindhoven.
19. Schmidt, V. (2007). *Vakdossier informatica*. SLO.
20. Shulman, L.S. (1987). Knowledge and Teaching: Foundations of the New Reform. *Harvard Educational Review*, 57(1), 1-22.
21. SLO (2015). Concept advies examenprogramma informatica havo/vwo.
22. Tew, A. E., & Guzdial, M. (2010). *Developing a validated assessment of fundamental CS1 concepts*. In Proceedings of the 41st ACM technical symposium on computer science education (pp. 97–101).
23. Tolboom, J., Krüger, J. & Grgurina, N. (2014). *Naar aantrekkelijk en actueel onderwijs in informatica*. SLO.

24. Vaniček, J. (2014). Bebras Informatics Contest: Criteria for Good Tasks Revised. In: Gülbahar, Y. en Karataş, E. *ISSEP 2014, LNCS 8730*, pp. 17-28. Springer International Publishing Switzerland.
25. Wongsopawiro, D. (2012). *Examining science teachers' pedagogical content knowledge in the context of a professional development program*. Unpublished doctoral dissertation, Leiden University, The Netherlands.
26. Yadav, A., Burkhart, D., Moix, D., Snow, E., Bandaru, P. & Clayborn, L. (2015). *Sowing the Seeds: A Landscape Study on Assessment in Secondary Computer Science Education*. Computer Science Teachers Association.

Expectations and motivation to attend Doctoral Consortium

This will be my second time joining this research school. Last year I enjoyed my stay very much, I liked the discussions, I have learned a lot of new things and it helped me to improve my research proposal.

This year I hope again to be able to share my thoughts, ideas and experiences with a lot of open minds, critical colleagues, and to receive suggestions to improve my thinking, to add to my to-do-, to-read- and to-study-lists.

The other side of the coin is that I have my experience to offer. I have worked for over 30 years as a teachers trainer, I have assisted around 40 schools in starting with courses in computer science, and I am involved in the Olympiad in Informatics and in the Bebras Contest. I look forward to meeting the people from this international community, and also to meet with new and other people that are interested in research on computer science education.

After this doctoral school I will have to defend my research proposal. This will be an important step; I hope to get a grant that will enable me to create time to actually do my research. I expect that our discussions will help prepare me for this interview.

RESEARCH OF TESTS GENERATION AND VALIDATION FOR INFORMATICS EDUCATION

Vinikienė Lina

Second year PhD student
Vilnius University Institute of Mathematics and Informatics
Akademijos str. 4, Vilnius, Lithuania
lina.vinikiene@mii.vu.lt

Brief Biography

I studied a program of distance learning information technologies and got master degree in Vilnius Gediminas Technical University. I started my research in PhD studies in Vilnius University two years ago and started working in the Institute of Mathematics and Informatics this autumn.

I was interested in e-learning education, e-assessment, learning strategies and technologies during my studies and work, before PhD studies. Now I focus on my research about the validation of informatics education tests, assessment.

Publications:

D. Giordano, F. Maiorana, A. Csizmadia, S. Marsden, C. Riedesel, S. Mishra, L. Vinikiene. New horizons in the assessment of computer science at school and beyond: leveraging on the ViVA platform. In Proceedings of the 20th Annual Conference Reports on Innovation and Technology in Computer Science Education -Working Group Reports, ITiCSE- WGR '15, New York, NY, USA, 2015. ACM (in press).

Research area description

In this research, I will explore parameters that evaluate or influence the assessment of student skills, abilities, knowledge. The basic idea of my research are based on the test theory. I will try to find the best method to evaluate validity of test, test questions and create strategies how to choose questions for the test whose aim is to evaluate student competences. This research will be an interdisciplinary research (informatic and education).

The first step of my research is to find methods, theory which could be used to evaluate validity of tests and also to find the best practices how teacher (or other person who create the test) should create questions of the tests. There are very important thing to clarify concepts of an assessment, test, competences, the principle of test creation.

The second task of my research is to find answers to this questions: if test are generated in the system, who are responsible for creation of the test (teacher, system, etc.), which metadata are or should be described in a system of the test. The research will be based on automated test generation.

In addition, all research is based on the assessment of competences of informatics education. So, I should investigate the dependency between parameters which describe selected test theory or method and competences which should be evaluated using the tests.

During all research steps I will define the parameters which allow us to define validity of the test, test value and which competences will be evaluated.

The aim of research is to create recommendation lists of reliability assessment of informatics and suggest better methods for evaluation of test validity and reliability.

The outline of the current knowledge of the problem domain

Nowadays educational organization develop test system for the assessment of student knowledge. That systems have to fit the requirements of learning and teaching model or standart of tests. The main problem of this process is to identify correct assessment of the knowledge, especially competences, and describe item difficulty. Organization like the Test Commission emphasize the importance of validity (Abad, F. et al. 2013).

Different methods of tests generation are being used (Daneliene R., Telesius, E., 2009). Methods are complicated and require to measure dependency between cognitive inputs and cognitive attributes, goals of the testing (Lamb, R. et al. 2014). There exist classical test theory and item response theory.

In the classical test theory are not define how different person or group will answer the specific questions. The statistic of the test depends on selected items, item difficulty, item discrimination (Asert, K. at al., 2014). Asert (2014) investigate competences and skills of information communication technologies based on classical test theory. He represent the matrix of this competences and skills, but this theory is not sufficient to evaluate latent variable, which „can not be observed or determined by directed measurement“ (Fayers, P. M., 2007), or evaluate answer then the parameter of test attempt depends on validity. The classical test theory should be evaluated again then the second test results is different from the first. We can simulate item complexity, test statistic, which is not depending on student and his mark (Hambleton et al., 1991, Lamb, R. et al. 2014). Item Response Theory (IRT) are used in Computerized Adaptive Tests as a modern mental test theory (Fayers, P. M., 2007). IRT works when there is a need to determine a student's level of knowledge, but not measuring the student's knowledge in every concept or level in the course. For example, in the article “Measuring Student Competences” are mentioned that “the main goal of IRT analysis is the estimation of two parameters: the item difficulty ... and person parameters” (Hubwieser, P., et al., 2014). IRT is used analyze test score and the impact of the proportion how „easy“ or hard“ is the task (Forišek, M., 2009). Forišek (2009) clarify that, this test theory could „work“ as the rating system. IRT model include latent variables and item parameters. So, the task is to find effective method for validity of the test. Some tools exist. Test generation system uses the ontology “to memorize pieces of knowledge of application” or has been used as a persistent level by test system (Bogdan, C. M., Ciobanu, G., 2013). Fan (1988) mentioned, that the invariance property of “IRT model parameters makes it theoretically possible to solve some important measurement problems that have been difficult to handle within the classical test theory framework.”

The next preliminary steps are to define the main feature of item response theory and classical test theory which are applied in the analyze of informatics test statistics, to define parameters for test validation and generation and to join it with competences.

Bibliographical references

1. Abad, F. S., Aguado, D., Garcia, P. E., Olea, J. (2013). A new IRT-based standard setting method: Application to eCat-Listening in *Psicothema*, Vol. 25, No.2, 238-244. Doi:10.7334/psicothema2012.147
2. Asert, K. et al. (2014). Direct measures of digital information processing and communication skills in primary education: Using item response theory for the development and validation of an ICT competence scale in *COMPUTERS & EDUCATION* Volume: 76 Pages: 168-181
3. Bogdan, C. M., Ciobanu, G. (2013). Ontology-based development of a students evaluation system. The 9th International Scientific Conference eLearning and software for Education, issue:01/2013, 238-243.
4. Danielienė, R., Telešius, E. (2009). Internetinės ECDI testavimo sistemos inovatyvūs sprendimai in *Informacijos mokslai*. ISSN-1392-0561
5. Fayers, P. M. (2007). Applying item response theory and computer adaptive testing: the challenges for health outcomes assessment. *Qual Life Res* 16:187-194. Doi:10.1007/s11136-007-9197-1
6. Fan, X. (1988). Item response theory and classical test theory: an ampirical comparison of their itme/person statistics in *Educational and psychological Measurement*.
7. Forišek, M., (2009). Using Item Response Theory to Rate (not only) Programmers in *Olympiads in Informatics*, Vol.3, 3-16
8. Hambleton, R. K., Swaminathan, H., & Rogers, H. J. (1991). Fundamentals of item response theory. New Bury, California: Sage Publications.
9. Hubwieser, P. , et.al. (2014). Measuring Student Competences In German Upper Secondary Computer Science Education in Informatics in School. Teaching and Learning Perspectives. Springer, Heidelberg, New York u.a, pp. 100–111.
10. Lamb R. et al. (2014). Cognitive diagnostic like approaches using neural-network analysis of serious educational videogames in *COMPUTERS & EDUCATION* Volume: 70 Pages: 92-104

Expectations and motivation to attend Doctoral Consortium

The main goal of my participating in consortium is to received new experience, to hear different opinions, rethinking my research goals, methods. I hope to receive very critical comments, because it leads to development of good research.